

**Please, read this manual
carefully before use!**

User Manual



Cordless impact screw driver

KS ISD20V-260-4

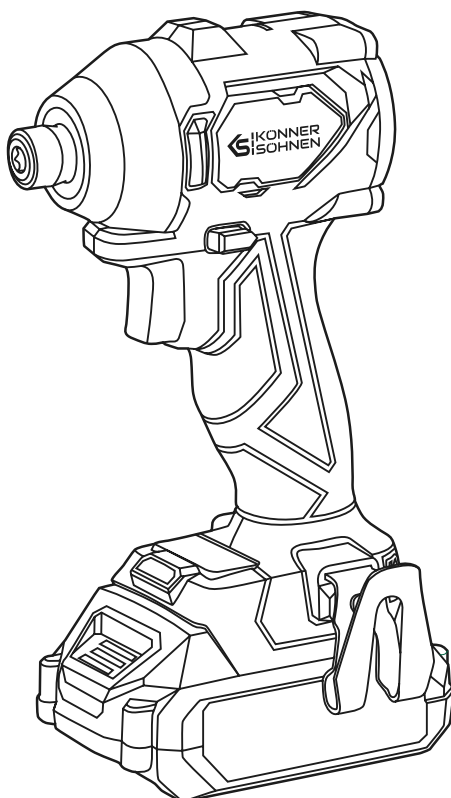



Thank you for choosing **Könnér & Söhnen®** products. This manual contains a brief description of safety, setup and use. More information can be found on the official importer's website in the support section: **konner-sohnen.com/pages/instructions**

You can also go to the support section and download the manual by scanning the QR code or on the website of the official importer of **Könnér & Söhnen®** at **www.konner-sohnen.com**



Please, read this manual carefully before use!

The manufacturer of **Könnér & Söhnen®** products reserves the right to make changes that may not be reflected in this manual, namely:

- The manufacturer reserves the right to make changes in the product design, configuration and construction.
- The images and drawings in this manual are for reference only and may differ from the actual components and inscriptions on the products.

Contact information that you are free to use in case of any problems can be found at the end of this manual. All information in this user manual is up-to-date as of the time of publication. The current list of service centers can be found on the official importer's website at **www.konner-sohnen.com**



ATTENTION – DANGER!



Failure to follow the recommendations marked with this sign may lead to serious injury or death of the operator or third parties.



IMPORTANT!



Useful information while operating the machine.

IMPORTANT SAFETY INFORMATION

1

GENERAL POWER TOOL SAFETY WARNINGS



WARNING!



Failure to follow these instructions may result in damage to the product, other materials, or the surrounding area.

WORK AREA SAFETY

- Keep work area clean and well lit. Clutter or darkness in the work area can cause accidents.
- Do not operate power tools in explosive atmospheres, such as in the presence of flammable liquids, gases or dust. Power tools create sparks, which may ignite the dust or fumes.
- Keep children and bystanders away while operating the power tool. Distractions can lead to loss of control over the tool.

ELECTRICAL SAFETY

- Avoid body contact with grounded surfaces such as pipes, radiators, stoves, and refrigerators. Contact with grounded surfaces increases the risk of electric shock.
- Do not expose power tools to rain or wet conditions. Water entering a power tool will increase the risk of electric shock.

PERSONAL SAFETY

- Stay alert, watch what you are doing, and use common sense when operating the power tool. Do not use the power tool while you are tired or under the influence of drugs, alcohol or medication. A moment of inattention while operating power tools may result in serious personal injury.

- Use personal protective equipment. Always wear eye protection. Protective equipment such as a dust mask, non-skid safety shoes, hard hat or hearing protection used for appropriate conditions will reduce personal injuries.
- Prevent unintentional starting. Ensure the switch is in the off-position before connecting to a power source and/or battery pack, picking up or carrying the tool. Carrying power tools with your finger on the switch or energizing power tools that have the switch on increases the risk of accidents.
- Remove any adjusting key or wrench before turning the power tool on. A wrench or a key left attached to a rotating part of the power tool may result in personal injury.
- Do not overexert yourself. Always maintain your balance. This enables better control of the power tool in unexpected situations.
- Dress appropriately. Do not wear loose clothing or jewellery. Keep your hair, clothing, and gloves away from moving parts. Loose clothes, jewellery or long hair can be caught in moving parts.

POWER TOOL USE AND CARE

- Do not force the power tool to work beyond its limits. Use the appropriate tool for your task. A properly selected tool works more efficiently and safely within the limits it was designed for.
- Do not use the power tool if the switch does not turn it on and off. Any power tool that cannot be controlled with the switch is dangerous and must be repaired.
- Disconnect the plug from the power source and/or the battery pack from the power tool before making any adjustments, changing accessories, or storing power tools. Such preventive safety measures reduce the risk of starting the power tool accidentally.
- Store idle power tools out of the reach of children, and do not allow persons unfamiliar with the power tool or these instructions to operate the power tool. Power tools are dangerous in the hands of untrained users.
- Maintain power tools. Check for misalignment or binding of moving parts, breakage of parts and any other condition that may affect the power tool's operation. If damaged, have the power tool repaired before use. Many accidents are caused by poorly maintained power tools.
- Keep cutting tools sharp and clean. Properly maintained cutting tools with sharp cutting edges are less likely to bind and are easier to control.
- Use the power tool, accessories and tool bits etc. in accordance with these instructions, taking into account the working conditions and the work to be performed. Use of the power tool for operations different from those intended could result in a hazardous situation.
- Keep handles and gripping surfaces dry, clean and free from oil and grease. Slippery handles and gripping surfaces make it difficult to safely control the tool in unexpected situations.

BATTERY TOOL USE AND CARE

- Recharge only with the charger specified by the manufacturer. A charger that is suitable for one type of battery pack may create a risk of fire when used with another battery pack.
- Use power tools only with specifically designated battery packs. Use of any other battery packs may create a risk of injury and fire.
- When the battery pack is not in use, keep it away from other metal objects, like paper clips, coins, keys, nails, screws or other small metal objects, that can make a connection from one terminal to another. Shorting the battery terminals together may cause burns or a fire.
- Do not use damaged or modified battery packs or tools. Damaged or modified batteries may behave unpredictably, which can lead to fire, explosion, or injury.
- Follow all charging instructions and do not charge the battery pack or tool outside the temperature range specified in the instructions. Charging improperly or at temperatures outside the specified range may damage the battery and increase the risk of fire.

IMPORTANT SAFETY INSTRUCTIONS FOR BATTERY CARTRIDGE

- Before using battery cartridge, read all instructions and cautionary markings on battery charger, battery, and product using the battery.
- Do not disassemble the battery cartridge.

- If operating time has become excessively shorter, stop operating immediately. It may result in a risk of overheating, possible burns and even an explosion.
 - If electrolyte gets into your eyes, rinse them out with clean water and seek medical attention right away. It may result in loss of eyesight.
 - Do not short-circuit the battery cartridge:
 1. Do not touch the terminals with any conductive material.
 2. Avoid storing the battery cartridge in a container with other metal objects such as nails, coins, etc.
 3. Do not expose the battery cartridge to water or rain.
- A battery short-circuit can cause a large current flow, overheating, possible burns and even a breakdown.
- Do not store the tool and battery cartridge in locations where the temperature may reach or exceed 50 °C (122 °F).
 - Do not incinerate the battery cartridge even if it is severely damaged or is completely worn out. The battery cartridge can explode in a fire.
 - Be careful not to drop or strike the battery.
 - Do not use a damaged battery.

TIPS FOR MAINTAINING MAXIMUM BATTERY LIFE

- Charge the battery cartridge before it is completely discharged. Always stop tool operation and charge the battery cartridge when you notice a decrease in the tool power.
- Never recharge a fully charged battery cartridge. Overcharging shortens the service life of the battery.
- Charge the battery cartridge at a room temperature of 10 °C – 40 °C (50 °F – 104 °F). Let a hot battery cartridge cool down before charging it.
- Charge the battery cartridge every six months if you do not use it for a long period of time.







SERVICE

- Have your power tool serviced by a qualified repair person using only identical replacement parts. This will ensure that the safety of the power tool is maintained.
- Follow instructions for lubricating and changing accessories.
- Keep handles dry, clean and free from oil and grease.
- Do not modify or attempt to repair the appliance or the battery pack except as indicated in the instructions for use and care.

CORDLESS IMPACT DRIVER SAFETY WARNINGS

2

- Hold the power tool by insulated gripping surfaces, when performing an operation where the fastener may contact hidden wiring. Fasteners contacting a “live” wire may make exposed metal parts of the power tool “live” and could give the operator an electric shock.
- Always be sure you have a firm footing. Be sure no one is below when using the tool in high locations.
- Hold the tool firmly.
- Wear ear protectors.
- Do not touch the bit or the workpiece immediately after operation. They may be extremely hot and could burn your skin.
- Keep hands away from rotating parts.
- Use auxiliary handle(s), if supplied with the tool. Loss of control can cause personal injury.
- Hold the power tool by insulated gripping surfaces, when performing an operation where the cutting accessory may contact hidden wiring. Cutting accessories contacting a “live” wire may make exposed metal parts of the power tool “live” and could give the operator an electric shock.

	Read all safety warnings and all instructions. Failure to follow the warnings and instructions may result in electric shock, fire and/or serious injury.
	Warning! Risk of cutting injury. Keep your hands and feet away.
	Wear personal protective equipment. Basically, wear protective goggles or, even better, face protection, safety helmet, safety gloves.
v	Volts.
	Direct current.
n₀	No load speed.
.../min r/min	Revolutions or reciprocating strokes per minute.
	Number of blows.
CE	This power tool complies with applicable European directives.
	Electrical appliances must not be disposed of with the domestic waste.

MAIN OVERVIEW

4

1. Battery port
2. LED light
3. Torque adjustment panel
4. Quick-change chuck
5. Head cover cap
6. Forward/reverse button
7. ON/OFF Switch
8. Soft grip
9. Belt clip

PACKAGE CONTENT LIST

- 20V Lithium Battery
- Charger for 20V Lithium Battery

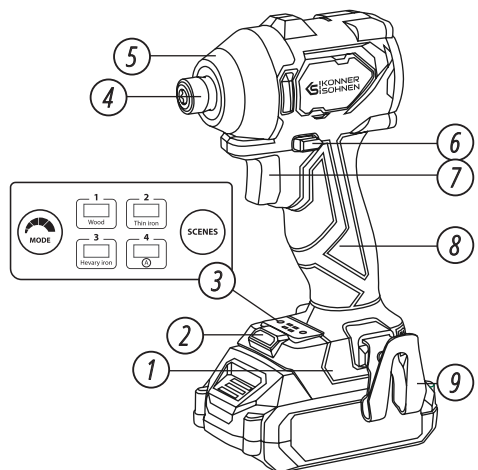



IMPORTANT!



The manufacturer reserves the right to make changes and/or improvements to the design, components, and technical specifications without notice or incurring obligation. The pictures in this manual are schematical and may not match the parameters of original product.

SPECIFICATIONS

5

Model	KS ISD20V-260-4
Rated voltage	DC 20V
Battery and charger	+
Max torque	260 N·m
Max no load speed	1900 / 2200 / 2800 / 3300 rpm
Impact rate	2500 / 2800 / 3400 / 4300 bpm
Torque	150 / 190 / 230 / 260 N·m
Motor type	brushless motor
Tool holder	1/4" shank
Gross/Net dimensions (L×W×H)	418×119×325/115×90×200 mm
Net weight	0,94 kg

ASSEMBLY

6



WARNING!



Always make sure that the tool is switched off and the battery cartridge is removed before carrying out any work on the tool.

INSTALLING OR REMOVING DRIVER/SOCKET BIT

Use only the driver/socket bit shown in the figure. Do not use any other driver/socket bit (Fig. 1).

To install the driver bit, insert it into the sleeve as far as it will go (Fig. 2).

To remove the driver bit, pull the sleeve in the direction of the arrow and pull the driver bit out (Fig. 3).

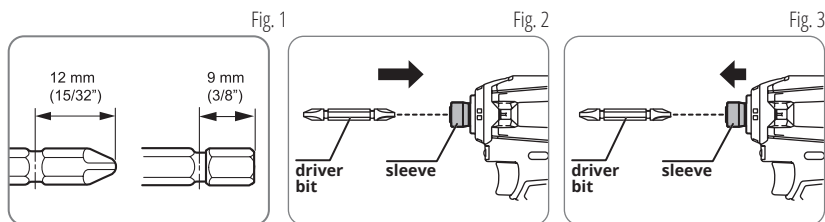

Note:

- If the driver bit is not inserted deep enough into the sleeve, the sleeve will not return to its original position and the driver bit will not be secured. In this case, try re-inserting the bit according to the instructions above.
- When it is difficult to insert driver bit, pull the sleeve and insert it into the sleeve as far as it will go.
- After inserting the driver bit, make sure that it is firmly secured. If it comes out, do not use it.

INSTALLING HOOK



WARNING!



When installing the hook, always secure it with the screw firmly. If it is not secured, the hook may come off the tool and cause personal injury.

The hook is convenient for temporarily hanging the tool. It can be installed on either side of the tool. To install the hook, insert it into a groove in the tool housing on either side and then secure it with a screw. To remove it, loosen the screw and then take it out.

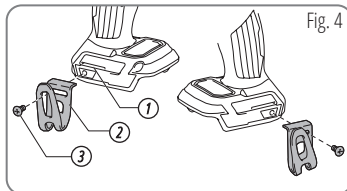

1.Groove 2.Hook 3.Screw

FUNCTIONAL DESCRIPTION

7

INSTALLATION AND REMOVAL OF THE BATTERY



ATTENTION – DANGER!



Make sure the battery is properly installed. If it is not securely fixed, it may cause injury.



WARNING!



Do not use force to attach the battery. If it is not easy to attach, it is not correctly aligned.

To attach the battery

1. Align the battery to the slots in the casing.
2. Push the battery in until it clicks into place.

To remove the battery

1. Press the button on the front of the battery.
2. Pull the battery out from the battery port.

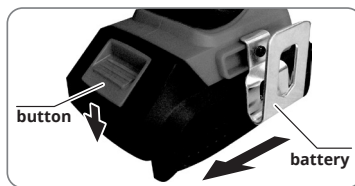

TOOL / BATTERY PROTECTION SYSTEM

The tool is equipped with a tool/battery protection system. This system automatically cuts off power to the motor to extend the life of the tool and battery. The tool will automatically stop during operation if any of the following conditions occur with the tool or battery:

Overload protection

If the tool consumes too much current, it automatically shuts down. In this case, turn the tool off and stop the operation that caused the tool to become overloaded. Then turn the tool on to restart.

Overheat protection

When the tool/battery is overheated, the tool stops automatically. In this situation, let the tool/battery cool down before turning the tool on again.

Overdischarge protection

When the battery capacity is not enough, the tool stops automatically. In this case, remove the battery and recharge it.

BATTERY CHARGE LEVEL INDICATOR

Press the check button on the battery cartridge to display the remaining battery capacity. The indicator lights will illuminate for a few seconds.

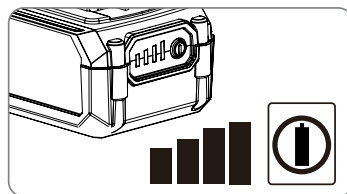











NOTE



Depending on the conditions of use and the ambient temperature, the indication may differ slightly from the actual capacity.

Indicator lamps			Remaining capacity
Lighted 	Off 	Blinking 	
			75% to 100%
			50% to 75%
			25% to 50%
			0% to 25%
			Charge the battery

SWITCH ACTION



WARNING!



Before installing the battery cartridge into the tool, always check to see that the switch trigger actuates properly and returns to the "OFF" position when released.

To start the tool, simply press the switch trigger (7). Tool speed is increased by increasing pressure on the switch trigger. Release the switch trigger to stop.

Note:

- The tool automatically stops if you keep pulling the switch trigger for about 6 minutes.
- While pulling the switch trigger, any other buttons do not work.

ELECTRIC BRAKE

This tool is equipped with an electric brake. If the tool consistently fails to quickly stop after the switch trigger is released, have the tool serviced at service center.

FRONT LAMP LIGHTING



ATTENTION - DANGER!



Do not look at the lamp or directly at the light source.

Press the switch trigger to light up the lamp (2). The lamp keeps on lighting while the switch trigger is being pressed. The lamp goes out approximately 10 seconds after releasing the switch trigger.

Note:

- If the tool is overheated, the light flashes for one minute, and then the LED display turns off. In this case, let the tool cool down before continuing work.
- To check the status of the indicator, press the trigger. When the lamp lights up by pressing the switch trigger, the lamp status is ON. If it does not light up, the status is OFF.
- To clean the indicator lens, use a dry cloth. Avoid scratching the lens, as this may reduce brightness.

REVERSE BUTTON (FIG. 5)



WARNING!



Always check the direction of rotation before operation.



WARNING!



Use the reverse button (6) only after the tool comes to a complete stop. Changing the direction of rotation before the tool stops may damage the tool.



WARNING!



When the tool is not in use, always set the reverse button (6) to the neutral position.

This tool is equipped with a reverse button to change the direction of rotation.

Press the reverse button on side A for clockwise rotation or on side B for counterclockwise rotation.

When the reversing switch lever is in the neutral position, the switch trigger cannot be pressed.

CHANGING THE WORKING MODE (FIG. 6)

To change the torque, press the "Mode" button, the light below "1", "2", "3", "4" will light up green. "1", "2", "3", "4" correspond to different torque levels.

To switch to another work mode, press the "SCENES" button. The indicator will light up red. Different indicators correspond to the "wood," "thin metal," and "thick metal" modes.

To enable the automatic stop function, first set the reverse rotation, then press the "SCENES" button repeatedly until the indicator above "A" lights up red.

Fig. 5

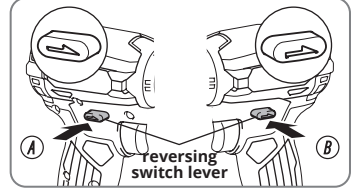
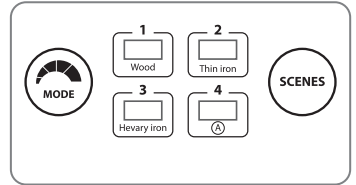
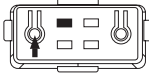
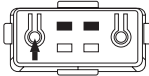
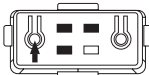
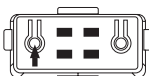
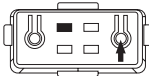
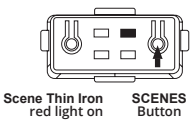
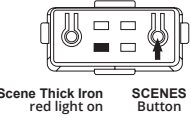
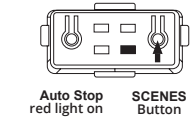

Fig. 6



DESCRIPTION OF BUTTON FUNCTIONS

		Function description
Direction of rotation FORWARD ROTATION	 <p>MODE Button 1st gear, green light on</p>	Working direction of rotation: Gear 1 No-load speed: 1900±10% rpm Impact rate: 2500 bpm Torque: 150 N·m
	 <p>MODE Button 2nd gear, green light on</p>	Working direction of rotation: Gear 2 No-load speed: 2200±10% rpm Impact rate: 2800 bpm Torque: 190 N·m
	 <p>MODE Button 3rd gear, green light on</p>	Working direction of rotation: Gear 3 No-load speed: 2800±10% rpm Impact rate: 3400 bpm Torque: 230 N·m
	 <p>MODE Button 4th gear, green light on</p>	Working direction of rotation: Gear 4 No-load speed: 3300±10% rpm Impact rate: 4300 bpm Torque: 260 N·m
	 <p>Scene Wood red light on SCENES Button</p>	<p>Scene Mode: Wood</p> <p>The speed at startup is relatively low, making it easier to align the screwdriver with the screw. When the screw is driven into the wood, the controller chip detects resistance and the speed slowly increases to the maximum gear, allowing the screw to be driven into the wood efficiently.</p>

	 <p>Scene Thin Iron red light on</p> <p>SCENES Button</p>	<p>Scene Mode: Thin Iron</p> <p>The speed is the highest at startup, which is convenient for drilling thin steel plates. When the screw is screwed in, the controller chip receives a resistance signal and the machine stops automatically. Manual control is not required, which can effectively control the screw slippage phenomenon. Suitable for working with thin metal sheets.</p>
	 <p>Scene Thick Iron red light on</p> <p>SCENES Button</p>	<p>Scene Mode: Thick Iron.</p> <p>The highest speed at the beginning of operation, which is convenient for drilling through thick steel plates. When the screw is screwed in, the controller detects the resistance signal, and the machine automatically reduces the speed and slowly cuts the thread. Manual control is not required, which effectively prevents the screws from slipping and not being fixed. Suitable for thick square pipes with a thickness of more than 5 mm.</p>
<p>Direction of rotation REVERSE ROTATION</p>	 <p>Auto Stop red light on</p> <p>SCENES Button</p>	<p>Reverse Autostop</p> <p>The speed is the highest at startup, and switches to a lower speed until it stops completely after 2 seconds of operation to prevent the screws from flying out due to excessive speed when unscrewing the screws.</p>

OPERATION 8

The proper fastening torque may vary depending on the type or size of the screw/bolt, the material of the workpiece to be fastened, etc. The relationship between fastening torque and fastening time is shown in the figures.

PROPER FASTENING TORQUE FOR STANDARD BOLT

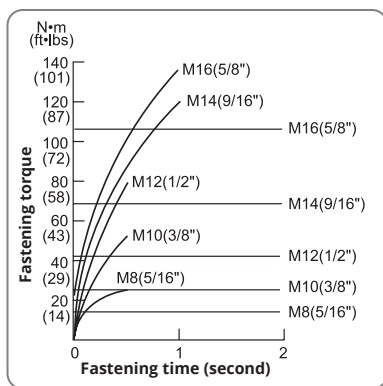

PROPER FASTENING TORQUE FOR HIGH TENSILE BOLT

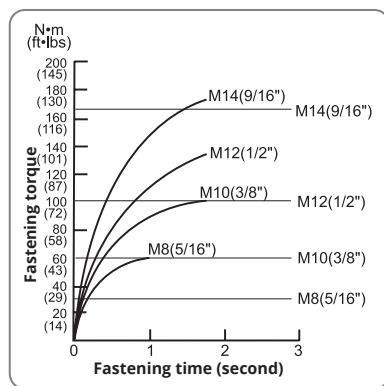

Hold the tool firmly and place the point of the driver bit in the screw head. Apply forward pressure to the tool to prevent the bit from slipping off the screw, then turn the tool on to start operation.



IMPORTANT!



If you use a spare battery to continue working, let the tool rest for at least 15 minutes.

Note:

- Use the appropriate bit for the type of screw/bolt head.
- When fastening M8 or smaller screw, choose a proper impact force and carefully adjust pressure on the switch trigger so that the screw is not damaged.
- Hold the tool pointed straight at the screw.
- If the impact force is too high or you fasten the screw longer than indicated in the figures, the screw or driver bit may be damaged or slip off. Always perform a test before starting work to determine the optimal fastening time.

The fastening torque is affected by a wide variety of factors including the following. After fastening, always check the torque with a torque wrench.

1. When the battery cartridge is almost completely discharged, voltage will drop, causing a reduction in fastening torque.
2. Driver bit or socket bit. Failure to use the correct size driver bit or socket bit will cause a reduction in the fastening torque.
3. Bolt:
 - Even though the torque coefficient and the class of bolt are the same, the proper fastening torque will vary according to the diameter of bolt.
 - Even though the diameters of bolts are the same, the proper fastening torque will vary according to the torque coefficient, the class of bolt and the bolt length.
4. The way the tool is held and the material of the fastening position will affect the torque.
5. Operating the tool at low speed will cause a reduction in the fastening torque.

MAINTENANCE AND STORAGE

9



ATTENTION – DANGER!



Stop the product and disconnect the power supply before you do maintenance.



WARNING!



To prevent damage to the surface of the product, do not use harsh detergents or abrasive cleaners..

STORAGE

- If the device is not going to be used for an extended period, remove the battery and store the device in a clean, dry place, out of reach of children and pets.
- Do not keep the product stored where the ambient temperature is less than 0 °C or more than 40 °C.

TRANSPORT

- Let the product come to a complete stop, become cool and remove the battery before you move the product.
- Use the handle when you lift or move the product.

TO CLEAN THE PRODUCT

- Clean the product with a soft and moist cloth if necessary.
- Keep the air vents free from debris.

DISPOSAL

Make sure to follow local regulations when disposing of the product. Electrical appliances must not be disposed of with the domestic waste.



SERVICING



WARNING!



Only approved personnel must do repairs on the product.

The power tool must only be serviced by qualified personnel using identical spare parts. This will ensure that the power tool remains safe to use.

WARRANTY SERVICE TERMS

10

Köner & Söhnen warrants the original purchaser of **power tools and battery powered and electric garden tools to 2 year** limited warranty, excluding Lithium-ion batteries that come in a set. Lithium-ion batteries which come in a set with power/garden tools or sold separately are covered with it's own warranty, described below.

- The warranty for **lithium-ion batteries is 2 years**, provided the product is registered on the website of the official importer <https://warranty.konner-sohnen.com> within 30 days of purchase. Without registration, the warranty is 1 year.
- The warranty for **brushless motors is 5 years**, provided the product is registered on the official importer's website <https://warranty.konner-sohnen.com> within 30 days of purchase. Without registration, the warranty is 2 years.



WARRANTY
REGISTRATION



EC Declaration of Conformity

Nr. 243

The following products have been tested by us with the listed standards and found in compliance with the European Community Machinery Directive 2006/42/EC, Electromagnetic compatibility Directive (EMC) 2014/30/EC.

Manufacturer: DIMAX INTERNATIONAL GmbH
Address: Flinger Broich 203, 40235 Duesseldorf, Germany
Product: Cordless impact screw driver "Könner & Söhnen"
Type / Model: KS ISD20V-260-4

The statement is based on a single evaluation of above mentioned products. It does not imply an assessment of the whole production and does not permit the use of the test lab. logo. The manufacturer should ensure that all product in series production are in conformity with the product sample detailed in this report. The applicant should hold the whole technical report at disposal of the competent all the right.

Applied EC Directives: 2006/42/EC Machinery Directive
2014/30/EC Electromagnetic compatibility Directive

Applied Standards: EN IEC 55014-1:2021
EN IEC 55014-2:2021
EN 62841-1:2015+A11:2022
EN 62841-2-2:2014

2000/14/EC_2005/88/EC Annex VI

For model KS ISD20V-260-4 noise guaranteed Lwa= 105 dB (A)



25

Issued Date: 2025-08-15
Place of issue: Duesseldorf
Director: Fomin P.

P. Fomin

DIMAX

International GmbH
Flinger Broich 203 40235 Düsseldorf
USt-ID DE296177274
koenner-soehnen.com

We DIMAX INTERNATIONAL GmbH hereby declare that specified above conforms covering European Parliament and Council Directives, 2006/42/EC of 17 May 2006 Machinery Directive, Electromagnetic compatibility Directive (EMC) 2014/30/EC of 26 February 2014. The CE mark above can be used under the responsibility of manufacturer. After completion of an EC declaration of Conformity and compliance with all relevant EC directives.

KONTAKTDATEN

Deutschland:

Hergestellt unter Lizenz und Kontrolle der DIMAX International GmbH.

Importeur und Vertreter in Deutschland:
DIMAX International GmbH Flinger Broich 203, 40235
Düsseldorf, Deutschland. Produziert in VRC.

amazon@dimaxgroup.com

www.konner-sohnen.com

European Union:

Manufactured under license and control of DIMAX International GmbH, Flinger Broich 203, 40235 Duesseldorf, Germany.

Importer and representative in Netherlands DIMAX International Poland Ltd, Południowa 8 st, 05-0830 Stara Wieś, Poland. Assembled in PRC.

amazon@dimaxgroup.com

www.konner-sohnen.com

The United Kingdom:

Innovation Trade Ltd., 63/66 Hatton Garden Fifth Floor, Suite 23, London, EC1N 8LE, info.uk@dimaxgroup.de

Technical support

support.uk@dimaxgroup.de

konner-sohnen.com.uk

France:

Fabriqué sous licence et contrôle de DIMAX International GmbH, Flinger Broich 203, 40235 Düsseldorf, Allemagne.

Importateur et représentant en France et en Belgique
DIMAX International Poland Ltd, Południowa 8 st,
05-0830 Stara Wieś, Pologne. Assemblé en RPC.

amazon@dimaxgroup.com

www.konner-sohnen.fr

España:

Fabricado bajo licencia y control de DIMAX International GmbH, Flinger Broich 203, 40235 Düsseldorf, Alemania.

Importador y representante en España de DIMAX International Poland Ltd, Południowa 8 st,
05-0830 Stara Wieś, Polonia.

Ensamblado en la República Popular China.

amazon@dimaxgroup.com

www.konner-sohnen.es

Polska:

Wyprodukowano na licencji i pod kontrolą DIMAX International GmbH, Flinger Broich 203, 40235 Duesseldorf, Niemcy.

Importer i przedstawiciel w Polsce:

DIMAX International Poland Sp.z o. o. ul. Południowa 8,
05-0830 Stara Wieś, Polska. Zmontowany w CRL.

amazon@dimaxgroup.com

www.konner-sohnen.pl

Україна:

Виготовлено за ліцензією та під контролем DIMAX International GmbH, Flinger Broich 203, 40235 Дюссельдорф, Німеччина.

Імпортер та представник в Україні:

ТОВ "ТЕХНО ТРЕЙД КС" вул. Електротехнічна 47,
02232, м. Київ, Україна. Змонтовано в КНР

www.konner-sohnen.com.ua