

KÖNNER SÖHNER

GARDEN

DIMAX
GROUP

2026





COMPANY DEVELOPMENT

EXCLUSIVE K&S-BRANDED ENGINES	3
HISTORY OF COMPANY DEVELOPMENT	4
QUALITY CERTIFICATES AND INTERNATIONAL AWARDS	8

POWER

UNIFIED BATTERY SYSTEM	12
BATTERIES AND CHARGING DEVICES	15
CORDLESS GRASS TRIMMERS	16
CORDLESS LAWN MOWERS	20
ROBOTIC LAWN MOWER	22
GRASS AND HEDGE TRIMMERS	24
CORDLESS PRUNERS	28
MINI CHAINSAWS	30
CORDLESS CHAINSAWS	32
CORDLESS LEAF VACUUM AND BLOWER	34

GRASS

ELECTRIC GRASS TRIMMERS	38
GASOLINE GRASS TRIMMERS	42
ELECTRIC LAWNMOWERS	46

WOOD

ELECTRIC CHAINSAWS	50
GASOLINE CHAINSAWS	52
AXE	60
LOG SPLITTERS AND WOOD CHIPPERS	62
WOOD CHIPPERS	68

SOIL

ELECTRIC TILLERS	74
GASOLINE TILLERS	76
MULTISEASON MULTIFUNCTIONAL MACHINE 4 IN 1	84

WATER

PRESSURE WASHERS	90
WATER PUMPS	94
K&S ACCESSORIES	100
BENEFITS FOR DEALERS	102
EXTENDED WARRANTY	103



DEAR CUSTOMERS AND PARTNERS,

Thank you for your trust and interest in **Könner & Söhnen®**.

We're proud to be part of your work and everyday life — helping you power what matters most.

Könner & Söhnen® began in Germany over two decades ago as a manufacturer of reliable generators, earning a reputation as a trusted partner known for precision, honesty, and long-lasting quality. Over time, we expanded into more mainstream products, including garden equipment, to give our customers access to dependable **KS-branded solutions** — not only in power generation but in every area where reliability matters.

What has never changed is our approach: **innovation rooted in tradition, high standards, and genuine care for customer satisfaction**. These principles guide everything we create — from powerful diesel units to compact garden tools built for comfort and durability.

Traditions of German Quality

is our DNA

We speak our customers' language — literally and figuratively. Our support team already communicates in eight languages and continues to grow, while our service centers operate across most European countries. In our offices and showrooms, specialists provide direct consultations and help select the right equipment for every need — from a small household garden to professional use in construction, agriculture, or municipal services.

We are more than manufacturers and sellers — we are partners and assistants. **K&S** equipment is used in applications ranging

from highly professional sectors such as defense, medicine, and utilities to everyday households, gardens, and garages. And beyond business, our technology serves where it's needed most. Across Europe, **K&S** products power social and charitable projects — from nursing homes and kindergartens to animal shelters and fire departments. This is how we give back: by providing reliable energy that helps people selflessly and strengthens communities.

By choosing **Könner & Söhnen®**, you choose more than a product. You choose a reliable partner that stands by your side — at work, at home, and in every situation where dependable equipment makes a difference.

EXCLUSIVE K&S-BRANDED ENGINES

Every **Könner & Söhnen®** product is powered by our own line of modern, high-performance engines — designed and refined by German engineers specifically for K&S.

Each engine undergoes a complete cycle of tests and inspections to ensure reliability, efficiency, and durability. Any potential imperfections are detected and eliminated right at the production stage, long before the product reaches your hands.

We hold a full license to manufacture **K&S engines** under our own brand and have obtained all required certificates confirming compliance with strict European and global standards — including the latest **EURO 5 emission regulations**. This means our engines are not only powerful, but also energy-efficient and environmentally responsible.

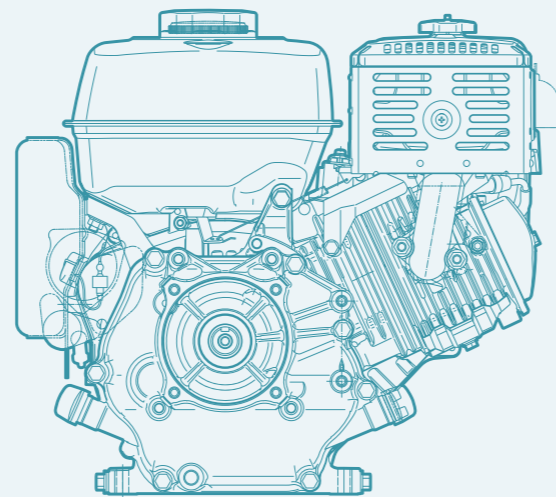

KEY ADVANTAGES OF K&S ENGINES:

- ✔ Guaranteed declared power output
- ✔ Reinforced, wear-resistant components
- ✔ Extended service life
- ✔ Multi-level factory testing
- ✔ Individual serial number for every engine
- ✔ Proprietary K&S design and engineering

Each engine installed in our generators or garden tools has its own unique serial number, ensuring full traceability, strict quality control, and reliable service support throughout its lifespan.

HISTORY OF COMPANY DEVELOPMENT

2010-2014

Development of the concept
The research and development of our own engine for the gasoline generator series

2014

3 countries

The registration of the 'Könner & Söhnen' trademark and the establishment of the Dimax group of companies.

Production of the first models of gasoline generators

2015-2016

6 countries

Start of production of a garden equipment range (tillers, water pumps).

Expansion of sales geography.

2017-2018

10 countries

Adding inverter and diesel generators to the product line.
Expansion of sales to Romania.



Received the prestigious 'Gold Medal' award in the 'Choice of Professionals'

2019-2020

15 countries

Breakthrough in R&D. Attracting new technologies, sharp expansion of sales geography.

Formation of the E-commerce department and the beginning of sales through electronic platforms.



Won the prestigious German Plus X Award in three categories: High Quality, Ease of Use, Functionality.

2021-2022

19 countries

Start of production of the Energy category with environmentally friendly energy sources - ESS, PPS.

Establishment of a warehouse network and organization of efficient delivery within Europe.

Sales across Europe.



Winner of the competition German Brand Award 2022 in two categories. The establishment of company in the USA and opening of a representative office in the Great Britain and Spain.

2023

20+ countries

Structuring of categories K&S Energy, K&S Garden, K&S Auto, K&S Construction.

Strengthening R&D work in the direction of K&S ENERGY.

Expansion of sales to the United States of America.



The Forbes magazine has awarded the "Forbes Diamonds 2023" title to DIMAX International Poland Sp. z o. o. as the fastest growing company that has chosen the right business strategy, based on the results of 2022.

2024

25+ countries

Expansion of sales to United Kingdom, Netherlands and Denmark.

Acquisition of a 10,000 m² land plot in Poland in 2024 for the development of a central European hub — including office space, showroom, warehouse, and facilities for assembly and production of goods for the Polish and EU markets.

2025

30+ countries

Rapid expansion of the Garden product line with the introduction of multiple new models, including a full battery-powered range.

Licence agreement with.



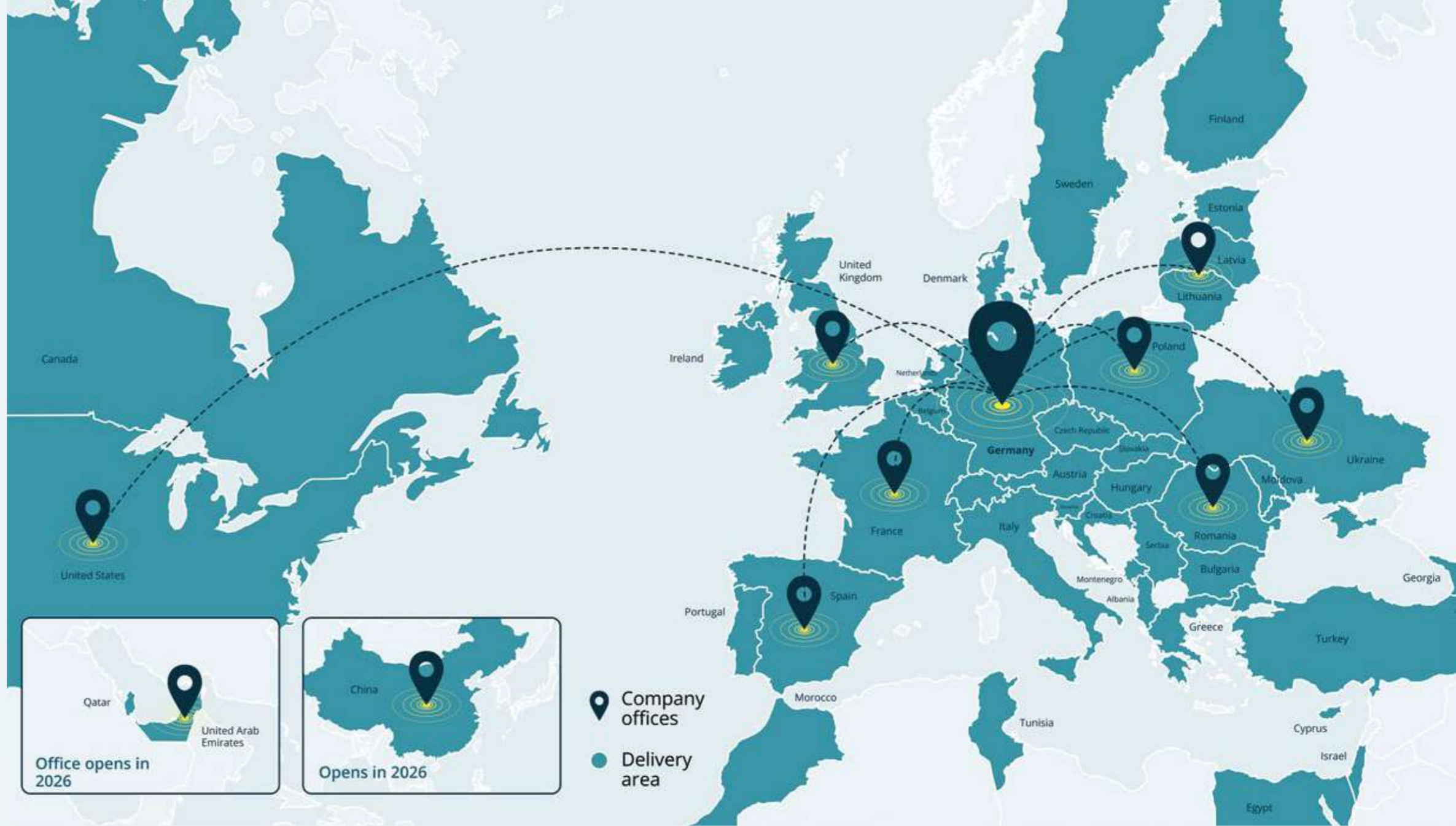

KÖNNER & SÖHNEN® IN 2025

Products provided by Könnner & Söhnen® are delivering power, durability, and precision across **Europe, the Middle East, Africa, and Latin America**. From power generators to garden tools, every product is built to outperform the competition in quality while remaining accessible and easy to use. Over 20 years later, our goal remains the same: keep innovating to meet needs, and keep serving people with the care and integrity that you expect from a trusted family-owned brand.



HEAD OFFICE:
DIMAX International GmbH
Flinger Broich 203, FortunaPark 40235 Düsseldorf, Germany



QUALITY CERTIFICATES

Köner & Söhnen® equipment meets all major European and international quality standards, including compliance with the latest EURO 5 emission regulations.

Each product is certified for efficiency, safety, and environmental responsibility — confirming that every K&S engine and tool meets the highest expectations of modern engineering.



INTERNATIONAL AWARDS

We are proud that the **quality and reliability** of Köner & Söhnen® products have been recognized by international experts and honored with **prestigious awards**.

Independent German specialists in technical innovation conducted detailed research and product testing, confirming that **K&S** delivers reliable equipment that stands out from mass production — combining **exclusive engineering solutions, long-term durability, and ease of use**.

These acknowledgments reflect what our customers already know: every K&S product is built with care, precision, and genuine respect for those who depend on it.



FORBES DIAMONDS 2025

Poland • 2025

Forbes awarded DIMAX International Poland Sp. z o.o. the title of **Forbes Diamonds 2025** winner, as one of the fastest-growing companies that has chosen the right strategy and is developing very dynamically.

The company's strategy focuses on forming a wide range of products with an emphasis on modern technologies and the development of new exclusive solutions, as well as competent structuring of the company and interaction both internally and externally, which allowed the company to achieve such success.



OUTSTANDING BRANDS

Germany • 2022

In 2022, Köner & Söhnen® equipment won the competition and simultaneously received two German awards **German Brand Award'22** in the following categories:

- ✓ Excellent Brands-Industry, Machines & Engineering
- ✓ Excellent Brands - Product Brand of the Year

Among 1200 submitted applications exclusively from German brands, independent experts distinguished Köner & Söhnen® equipment in two categories of Excellent Brands. The criteria for evaluation were transparent and open.



EXPERTS' CHOICE

Poland • 2018

In 2018, Köner & Söhnen® products received the prestigious **"Golden Medal" award in the "Experts' Choice" category in Poland**.

Köner & Söhnen® equipment was recognized by experienced European experts and professionals as equipment meeting advanced technology requirements. The award proves the quality of the products and the high production potential of Köner & Söhnen®.



PLUS X AWARD

Germany • 2019

In 2019, Köner & Söhnen® equipment received the prestigious German Plus X Award in three categories simultaneously:

- ✓ High quality
- ✓ Ease of use
- ✓ Functionality

Plus X Award is one of the world's largest awards recognizing the quality and innovation of products. German experts confirmed that Köner & Söhnen® products meet the highest quality requirements and that the equipment was designed with the needs of the most demanding customers in mind.



PRODUCT OF THE YEAR

Ukraine • 2016

In 2016, Köner & Söhnen® products received the "Ukrainian National Olympus" award and were recognized as "Best Product of the Year" in the category of garden equipment and generators based on the price-to-quality ratio.

Köner & Söhnen® has taken its place in the mid-price segment, offering consumers reliable high-quality equipment with all necessary European certificates at an affordable, democratic price.

BUSINESS CHEETAHS

Poland • 2022

Dimax International Poland Sp. z o.o. was awarded by the Institute of European Business in the XVII edition of the **Business Cheetahs 2022** competition, the XV edition of the Polish Economy Diamonds 2022, the XV edition of the **Effective Company 2022**, and the IX edition of the **Strong Company 2022**, based on financial data from the National Court Register.

DIAMOND OF THE POLISH ECONOMY



BUSINESS CHEETAH STATUETTE



EFFECTIVE COMPANY STATUETTE



STRONG COMPANY STATUETTE



The company is dynamically developing – the average revenue and net profit growth rate in 2019–2020 reached 454.86%, which earned us the title of **Business Cheetah 2022**.

The title of **Effective Company 2022** confirmed that company also operates effectively – the average net profit-to-revenue ratio in 2019 and 2020 reached 10.7%. Together, this ensured the title **Strong and Trustworthy Company 2022**.

The company's market value in March 2021 increased significantly, which gave it the title **Polish Economy Diamond 2022**.

Köner & Söhnen® German-brand equipment offers high quality at affordable prices.

POWER



UNIFIED
battery system



20V or 40V



The Könnert & Söhne® Unified Battery System brings simplicity and practicality to garden work. A single 20V lithium-ion battery powers more than 50 cordless tools – from trimmers and hedge cutters to lawn mowers, blowers, and chainsaws.

Choose the battery capacity that fits your tasks, connect it to any compatible tool, and keep working without interruptions. Fewer batteries mean lower costs, less storage, and more convenience.

Lightweight, powerful, and eco-friendly, this system combines mobility with real performance — helping both beginners and professionals work comfortably all year round.

UNIFIED BATTERY SYSTEM FROM KÖNNERT & SÖHNEN®

- ✓ Built for first-time gardeners and to seasoned pros
- ✓ Lightweight and easy to handle
- ✓ Low noise power for all-day comfort.
- ✓ Super easy maintenance

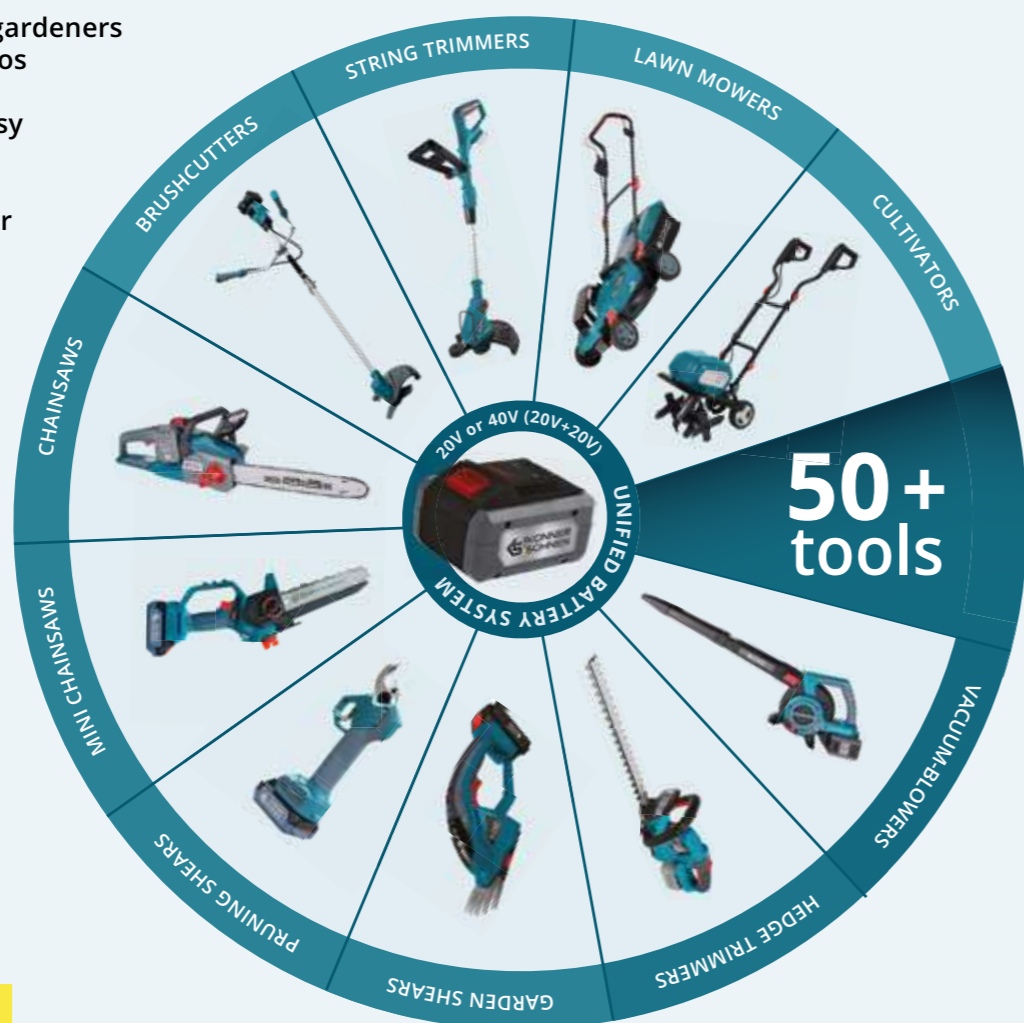

20V LITHIUM-ION BATTERY

ONE BATTERY – MANY TOOLS

One solution – maximum efficiency.

SMART CONTROL



Protective Frame – enforced shock protection against impact or drops.

IP67 Protection – fully sealed from dust and moisture for reliable outdoor use.

✓ Nickel Plate

✓ BMS protection



✓ Built for Safety and Long Life

MULTI-LEVEL PROTECTION SYSTEM AGAINST:



Overcharging



Overdischarging



Short circuit



Overcurrent



Overvoltage



Overheating

Modern Könnert & Söhne® lithium-ion batteries stand out for their high reliability and durability. Their service life is three times longer than that of lead-acid batteries. They are lightweight and compact, have a high capacity, and require no maintenance during their entire period of use.



BATTERIES AND CHARGING DEVICES

Könnert & Söhne® chargers provide stable power, intelligent control, and automatic protection from damage. LED indicators clearly show the charging status for quick and easy use.

20V LITHIUM-ION BATTERIES



	KS 20V2-1	KS 20V4-1	KS 20V4-2	KS 20V6-2	KS 20V8-2
Rated voltage	20 V	20 V	20 V	20 V	20 V
Battery capacity	2 Ah	4 Ah	4 Ah	6 Ah	8 Ah
Battery type	Lithium-ion	Lithium-ion	Lithium-ion	Lithium-ion	Lithium-ion
Lithium ion battery	5 cells	10 cells	5 cells	10 cells	10 cells
Battery capacity	2000Mah	4000Mah	4000Mah	6000Mah	8000Mah
Dimensions (L×W×H)	118×80×50 mm	118×80×72 mm	123×87×53 mm	123×87×72 mm	123×87×72 mm
Net weight	0,47 kg	0,79 kg	0,68 kg	1,09 kg	1,09 kg
EAN code	4 260405 367207	4 260405 367214	4 260405 367221	4 260405 367238	4 260405 367245

CHARGERS FOR 20V LITHIUM-ION BATTERIES



Fast charger for 20V lithium-ion batteries

Standard charger for 20V lithium-ion batteries

Dual fast charger for 20V lithium-ion batteries

	KS C24A	KS C45A	KS C35A-2
Rated voltage	230 V/50 Hz	230 V/50 Hz	230 V/50 Hz
Rated output voltage	21,5 V	21,5 V	21,5 V
Rated output current	2,4 A	4,5 A	2×3,5 A
Safety class	II	II	II
Dimensions (L×W×H)	140×64×92 mm	140×64×84 mm	220×65×135 mm
Net weight	0,42 kg	0,55 kg	0,89 kg
Gross weight	0,44 kg	0,58 kg	0,95 kg
EAN code	4 260405 367252	4 260405 367269	4 260405 367276

✓ ECONOMIC BENEFITS

Save more with one battery for all tools. Könnert & Söhne® universal batteries fit the entire cordless range — no need to buy a separate power source for each device. One purchase means less clutter, lower costs, and more efficiency.

✓ WORK COMFORT

No extra batteries to carry or charge — just swap between tools and keep going. Cordless designs without built-in batteries are lighter and more balanced in use.

✓ MAXIMUM MOBILITY

Full freedom of movement without dependence on mains power. Modern lithium-ion technology ensures stable performance, longer runtime, and efficient operation even in remote areas.

✓ ECO-FRIENDLINESS

Cordless tools produce no emissions and help reduce waste. Using one battery across many tools minimizes the number of batteries in circulation, contributing to cleaner, sustainable work.

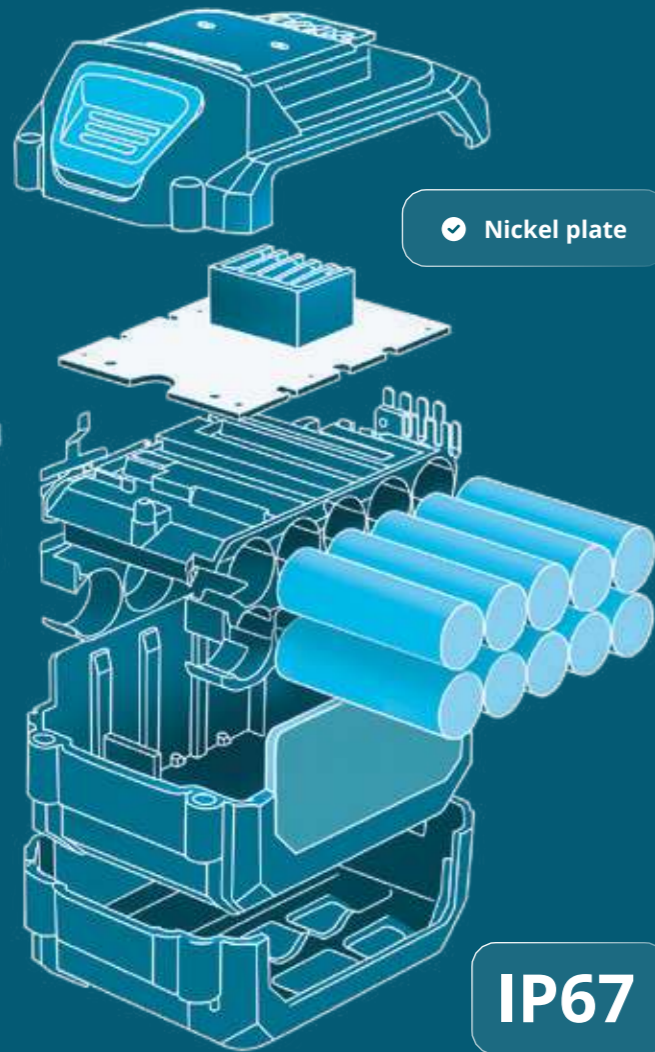

Nickel plate

IP67





CORDLESS GRASS TRIMMERS



Rated voltage



20 V / 40 V

Battery capacity*



2-8 Ah

Cutting width



10" (25 cm) - 12" (30 cm)

No-load speed



5500-8500 rpm

UNIVERSAL APPLICATION

K&S cordless trimmers are built for versatility.

Interchangeable attachments — a **three-tooth blade** for tougher work and a **line spool** for precise trimming — allow handling everything from grass edges to dense vegetation.

A standout in the range, the **KS MFT-20V multifunctional trimmer** combines **4 tools in 1**: cutting with a blade and knives, edging with a line, sweeping paths, and cleaning paving stones. This all-in-one solution is ideal for maintaining both private gardens and larger outdoor areas.



EASY OPERATION AND MAINTENANCE

- **Adjustable handle** for perfect height and angle
- **Telescopic boom** for easy adaptation to user height
- **Adjustable motor head** to switch between mowing and edging or adjust tilt for working around obstacles
- **Extendable protective frame** prevents accidental damage to nearby plants
- **Shoulder strap system** reduces strain during long operation
- **Compact, foldable design** for easy transport and storage

OVERHEAT PROTECTION

All **K&S cordless trimmers** include an **overheat protection system**. When a critical temperature is reached, the device automatically shuts off to cool down — protecting both the battery and the motor, and extending overall service life.



*Battery and charger are sold separately



KS GT-20V

The KS GT-20V trimmer features an adjustable, rubber-coated handle, a telescopic shaft, and a Tap&Go cutting head for efficient trimming. Additional blades are included for tougher vegetation, along with a support wheel for precise edge trimming.

Rated voltage	20 V
Motor type	Brushmotor
Cutting width	250 mm
Net weight	2 kg
EAN code	4 260405 368396

IN THE SET:

- 10 nylon blades
- Spool housing
- Blade holder



Grass cutting

Edge trimming mode

KS CST-20V

The KS CST-20V trimmer is a compact, user-friendly tool for grass cutting and edging. Features a telescopic shaft, rotating handle, automatic line feed, and two guide wheels for precision. Ideal for lawn maintenance.

Rated voltage	20 V
Motor type	Brushmotor
Cutting width	300 mm
Net weight	2.12 kg
EAN code	4 260405 368372

IN THE SET:

- Spool with 2.5 m line



Grass cutting

Edge trimming mode

KS MFT-20V

KS MFT-20V cordless 4-in-1 trimmer is ideal for maintaining lawns, flowerbeds, and edges. It features a rubber-coated grip, swivel handle, and telescopic shaft for comfort and control. A blade storage compartment, adjustable motor housing, and support wheel ensure precision, while its lightweight design allows effortless operation.

Rated voltage	20 V
Motor type	Brushmotor
Cutting width	250 mm
Net weight	3.75 kg
EAN code	4 260405 368402

IN THE SET:

- Trimmer block (line/blade)
- Edging block
- Sweeper block (Nylon brush + Metal brush)

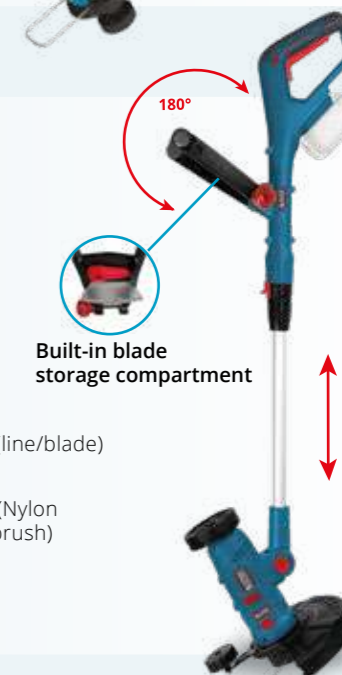

Grass Trimming

Edge Cutting

Joint Cleaning

Sweeping



POWERFUL BRUSHLESS MOTOR

This motor type features fewer moving parts, requires minimal maintenance, and ensures low noise levels during operation — ideal for comfortable, extended use.

KS BCT-20V

KS BCT-20V cordless trimmer is light and quiet model that features a brushless 7,500 rpm motor, intelligent speed control, and a semi-automatic spool for effortless, continuous work. Includes three-blade knife and line attachments, adjustable handle, and soft shoulder strap for comfort.

Rated voltage	20 V
Motor type	Brushless
Cutting width	300 mm
Net weight	3.8 kg
EAN code	4 260405 367122

IN THE SET:

- Shoulder strap
- 3-tooth blade
- Spool with 5 m line



KS BCT-40V

KS BCT-40V cordless trimmer offers full mobility, intelligent speed control, and a semi-automatic spool for efficient trimming. A U-shaped handle, shoulder strap, and detachable shaft ensure comfort, easy transport, and compact storage — keeping your yard perfectly neat with no cords attached.

Rated voltage	40 V (20 V + 20 V)
Motor type	Brushless
Cutting width	300 mm
Net weight	3.6 kg
EAN code	4 260405 367139

IN THE SET:

- Shoulder strap
- 3-tooth blade
- Spool with 5 m line



CORDLESS GARDEN TRIMMERS



	KS GT-20V	KS CST-20V	KS MFT-20V	KS BCT-20V	KS BCT-40V
Rated voltage	20 V	20 V	20 V	20 V	40 V (20 V + 20 V)
Battery capacity (not included)	2 - 8 Ah	2 - 8 Ah	2 - 8 Ah	2 - 8 Ah	2 - 8 Ah
Motor type	Brushmotor			Brushless	
Cutting head speed	8500 rpm	8000 rpm	8000 rpm	7500 rpm	7500 rpm
Blade speed	8500 rpm	-	-	5500 rpm	5500 rpm
Overheat protection	+	+	+	+	+
Smart controller	-	-	-	+	+
Max cutting width	250 mm	300 mm	250 mm	300 mm	300 mm
Line length	2 m	2,5 m	2 m	2x5 m	2x5 m
Line diameter	Ø1,6 mm	Ø1,8 mm	Ø1,6 mm	Ø2 mm	Ø2 mm
Rubberized handle	+	+	+	-	+
Multi-position handle	+	+	+	-	+
Adjustable motor housing	+	+	+	-	-
Element type	Tap&Go head with line, blade	Automatic head with line	Tap&Go head with line, blade, brush	Tap&Go head with line, blade	
Functions	Trimmer, edge trimmer	Trimmer, edge trimmer	Trimmer, edge trimmer, sweeper, cultivator	Trimmer, brush cutter	Trimmer, brush cutter
Dimensions (LxWxH)	950x250x100 mm	930x220x150 mm	976x280x222 mm	970x270x110 mm	970x270x100 mm
Net weight	2 kg	1,95 kg	3,75 kg	3,8 kg	3,6 kg
Gross weight	2,8 kg	2,75 kg	4,65 kg	4,8 kg	4,9 kg
EAN code	4 260405 368396	4 260405 368372	4 260405 368402	4 260405 367122	4 260405 367139

ACCESSORIES FOR THIS PRODUCT (sold separately) page: 15, 101





CORDLESS LAWN MOWERS

CORDLESS LAWN MOWERS



Rated voltage



20 V/40 V

Cutting width



330-430 mm

Cutting height



25-75 mm

Operating speed



3200-3300 rpm

TRADITIONELLE
DEUTSCHE
QUALITÄT



SMART DESIGN & EASY HANDLING

Height-adjustable handles make carrying, use, and compact storage easier

Battery charge level indicator (low, medium, full)

Foldable handle with quick-release clamp

Carrying handle

Cutting height adjustment lever, 5 or 6 positions (25-75 mm)

Wheels



BRUSHLESS
MOTOR



RPM

Intelligent speed control

An automatic motor speed adjustment system optimizes energy consumption and ensures maximum mowing efficiency under varying load conditions.

Grass catcher fill indicator

Mulching function

Grass catcher



*Battery and charger are sold separately

BRUSHLESS MOTOR TECHNOLOGY

Each mower is equipped with a high-efficiency brushless motor that delivers speeds up to 3300 rpm.

This advanced motor design ensures:

- High performance and stable torque under load
- Extended service life and lower noise levels
- Reduced maintenance thanks to fewer moving parts

The result — reliable performance season after season, even during demanding work.

FUNCTION 2-IN-1: GRASS COLLECTION OR MULCHING

Choose between **grass collection** or **direct mulching**. Mulching finely chops the grass and returns it to the soil, acting as a natural fertilizer and improving lawn health. A **43 cm cutting width** allows efficient mowing and mulching even on larger areas.

CUTTING HEIGHT ADJUSTMENT 25-75 MM

An easy-to-use lever allows **five or six height settings** (depending on the model) — from 25 mm to 75 mm. This lets you adapt the mower to your personal preference or seasonal conditions for a perfect finish every time.

LIGHTWEIGHT GRASS CATCHER

The **30-50 L grass catcher** combines a durable plastic lid with a synthetic fabric bag — light, stable, and easy to empty. A built-in **fill indicator** shows when the container needs to be emptied.

SAFETY KEY

Each mower is equipped with a **safety key** that must be inserted before starting. Removing the key immediately cuts off power, preventing accidental activation and ensuring safe transport and storage.

K&S Cordless Lawn Mowers — powerful, quiet, and built for effortless lawn care.

Excellent maneuverability thanks to balanced weight

Low vibration level for operator comfort

Tool-free assembly and compact storage



	KS 33LM-20V	KS 43LM-40V
Rated voltage	20 V	40 V (20 V+20 V)
Battery capacity (not included)	2-4 Ah	2-4 Ah
Operating speed	3200 rpm	3300 rpm
Motor type	Brushless motor	Brushless motor
Cutting width	330 mm	430 mm
Cutting height	25-75 (5 positions)	25-75 (6 positions)
Grass catcher capacity	30 l	50 l
Mulching function	+	+
Front/rear wheels	5,5"/6,5"	7"/10"
Dimensions (L×W×H)	690×410×330 mm	804×484×400 mm
Net weight	9,5 kg	12,5 kg
Gross weight	11,2 kg	15 kg
EAN code	4 260405 367047	4 260405 367054

ACCESSORIES FOR THIS PRODUCT (sold separately)
page: 15, 101





ROBOTIC LAWN MOWER

SMART. RELIABLE. FULLY AUTOMATED.



Rated voltage



20 V

Cutting width



220 mm

Cutting height



25–65 mm

Maximum working area



900 m²

POWERFUL PERFORMANCE

KS 22RLM delivers strong, consistent power for areas up to 900 m². Its integrated mulching system finely shreds grass and spreads it evenly across the lawn, enriching the soil and eliminating the need to collect clippings. The result: a healthier, greener lawn with zero effort.

170-meter boundary wire that defines the mowing area with precision and prevents the mower from leaving its zone **is included in the set** — for safe, fully automated operation.

MAXIMUM AUTOMATION

Equipped with a full range of intelligent sensors, the mower operates safely and independently:

- **Automatic return to charging station** after completing the mowing cycle
- **Programmable schedule** (set mowing hours and days)
- **Lift and tilt sensors** — instantly stop blades if the mower is raised or tilted
- **Obstacle detection and impact sensors** — change direction or stop operation when contact is detected
- **Rain sensor** — detects precipitation and automatically returns to the charging station
- **Water resistance:** IPX4 rating

RELIABLE LITHIUM-ION BATTERY

The **20 V / 4.0 Ah lithium-ion battery** provides stable power and extended runtime for efficient, uninterrupted operation.

- **Up to 70 minutes of continuous mowing** per charge.
- **Fast recharge and consistent performance.**
- **Lightweight, compact design.**
- **High energy density:** longer runtime with smaller size and lower weight than lead-acid batteries.



Könner & Söhnen® Robotic Mower — intelligent automation and precision cutting for a perfect lawn, every day.

POWER TO WIN



REMOTE CONTROL SMART CONNECTIVITY FOR COMPLETE CONTROL

The Könner & Söhnen® robotic mower can be managed easily through a **mobile app** via **Bluetooth or Wi-Fi connection**. Set the mowing schedule, start the device remotely, and monitor its progress — all from your smartphone.

- ✓ **Anti-theft protection:** the mower cannot be started without the PIN code.
- ✓ **User safety:** blades stop instantly if the mower is lifted.



BRUSHLESS MOTOR

The mower's **brushless motor** delivers powerful, efficient performance with a long service life and minimal maintenance. With fewer moving parts and reduced friction, it runs quietly and smoothly — ensuring reliable operation year after year.



Cutting height adjustment (25–65 mm)

Lift sensor (works on slopes up to 25° / 47%)

IPX4 water resistance

Automatic obstacle avoidance

Low noise level

Rain sensor

8" rubber wheels with tread

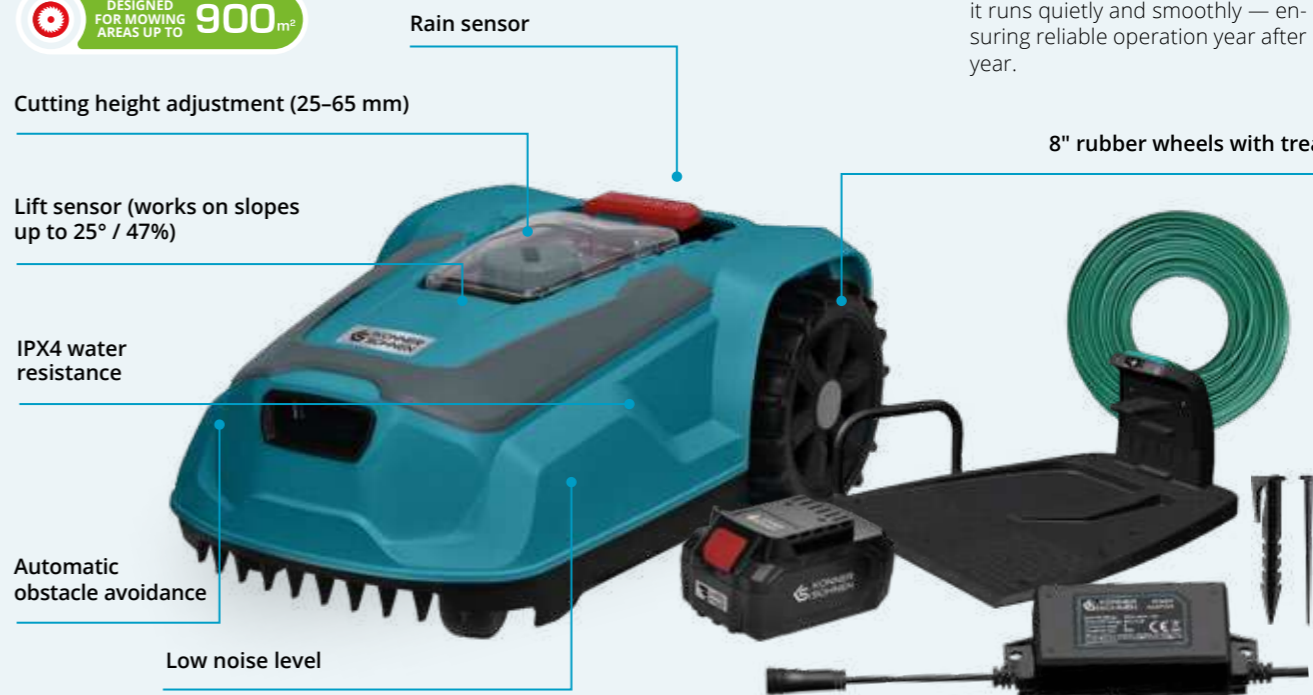

KS 22RLM

Motor voltage	20 V
Max. mowing area	up to 900 m ²
Mowing time per full battery charge (4 Ah)	up to 70 min*
Travel speed	1,2 km/h
No-load speed	3100 rpm
Cutting height (8 positions)	25–65 mm
Cutting width	220 mm
Incline angle	25°/47%
Wheels	8"
APP/Wi-Fi/Bluetooth	+
Dimensions (L×W×H)	470x280×360 mm
Net weight	9 kg
Gross weight	18 kg
EAN code	4 260405 367191

SELF-INSTALLATION KIT (INCLUDED):

- ✓ Boundary wire – 170 m
- ✓ Boundary wire stakes – 230 pcs.
- ✓ Ground nails for charging station – 6 pcs.
- ✓ Charging station
- ✓ Power adapter
- ✓ 20 V lithium-ion battery



* Depending on grass type, growth conditions, humidity, and lawn surface flatness.



GRASS AND HEDGE TRIMMERS



Rated voltage



8-20 V

Battery capacity



2-8 Ah

Cutting length



120-550 mm

Max. cutting diameter



Ø 7,5-16 mm

TRADITIONELLE
DEUTSCHE
QUALITÄT



KS HT-20V

CUTTING LENGTH **22"**
55 cm



Rotating handle – allows 180° rotation (5 handle positions)

Lock button

Safety guard

Max cutting diameter: 16 mm (3/5")

BATTERY IS NOT INCLUDED 20V

* Battery and charger not included in the set

External gearbox provides convenient access to components, making maintenance easier and faster

Dual-action blades (double cut)

CORDLESS HEDGE TRIMMERS

Könner & Söhnen® cordless hedge and grass trimmers deliver optimal power with **low vibration** for clean, accurate cuts. Depending on the model, a **rotating handle** (90° or 180°) allows comfortable trimming from any angle — perfect for shaping shrubs, cutting branches up to 16 mm thick, or tidying lawn edges. The compact design provides excellent control, while built-in safety systems — including a **switch lock**, **accidental start prevention**, and, in selected models, a **triple safety mechanism** and **battery charge indicator** — ensure safe, confident operation.

Reliable and user-friendly, these trimmers are ideal for both home gardeners and professionals.

✓ DOUBLE, PRECISE BLADES

High-quality hardened steel blades, laser-ground or precisely sharpened, deliver clean and even cuts every time. They easily handle both young shoots and thicker branches. Depending on the model, **blade length ranges from 120 mm to 550 mm**, ensuring flexibility for any task.

✓ THOUGHTFUL DESIGN

The **ergonomic, rubberized handle** provides a firm grip and reduces hand fatigue during long operation. A **rotating handle** allows comfortable positioning for every angle of work, while the **quick blade-change system** makes it easy to switch between different cutting types.

✓ LITHIUM-ION BATTERY

Powered by reliable **lithium-ion batteries** (8–20 V, 2000 mAh–8 Ah), the trimmers offer **fast charging, long runtime**, and cordless freedom. **For 20 V models, the battery and charger are sold separately.**

KS HT-20V cordless hedge trimmer is a **powerful, lightweight, and mobile tool**. Weighing just **2.5 kg**, it features low vibration and a **180° rotating handle** for optimal comfort and precise angle adjustment.

Ideal for **trimming bushes, hedges, and branches up to 16 mm in diameter**.

A **two-handle control system with accidental-start protection** ensures safety, while a **transparent front guard** shields the user's hand from debris without obstructing visibility.

✓ BLADES WITH LASER SHARPENING

The **55 cm** long cutting blade with double-action blades is made of durable steel with laser sharpening for a perfectly sharp cutting edge. It's effective for cutting both fresh shoots and branches of various plant species.

✓ ERGONOMIC DESIGN

The **rubberized handle** ensures a secure, non-slip grip and offers **five rotation positions within 180°**, allowing comfortable and efficient work from any angle.

Rated voltage	DC 20 V
Battery capacity (not included)	2 - 8 Ah
Cutting length	22" (55 cm)
Net weight	2,5 kg
EAN code	4 260405 367153



SOFT START

This **function** prevents sudden acceleration and reduces initial load on the motor, ensuring a **smooth, controlled start-up** and greater comfort, eliminating jerks and reducing wear on the tool.



CORDLESS GRASS AND HEDGE TRIMMERS

TRADITIONELLE
DEUTSCHE
QUALITÄT



KS SHT-8V

SHT-8V cordless grass shears are lightweight, easy-to-handle tools designed for trimming **grass, small shrubs, and ornamental plants**. A **rotating handle** allows comfortable work at different angles, while the **quick blade-change system** lets you adapt the shears instantly to various tasks. Powered by a **built-in 2000 mAh** rechargeable battery, the SHT-8V offers reliable runtime and full control over operation. A **triple safety system** ensures maximum protection, and the **ergonomic, low-weight design** provides lasting comfort even during longer garden sessions.



Rated voltage	DC 8 V
Battery capacity	2000 mAh
Max cutting diameter	7,5 mm
Net weight	1 kg
EAN code	4 260405 368419



Double-sided blades



KS SHT-20V

The **SHT-20V cordless 2-in-1 garden shears** combine functionality, comfort, and the freedom of cordless operation in one compact tool. Equipped with **high-quality double blades**, it delivers clean, precise cuts on **grass, shrubs, and hedges** alike. A **quick blade-change system** lets you switch between trimming modes in seconds, while a **lock switch** and **safety mechanisms** prevent accidental activation. Lightweight and ergonomically designed, the SHT-20V minimizes fatigue during long use, and its **20 V power system** provides ample energy for all everyday garden tasks.

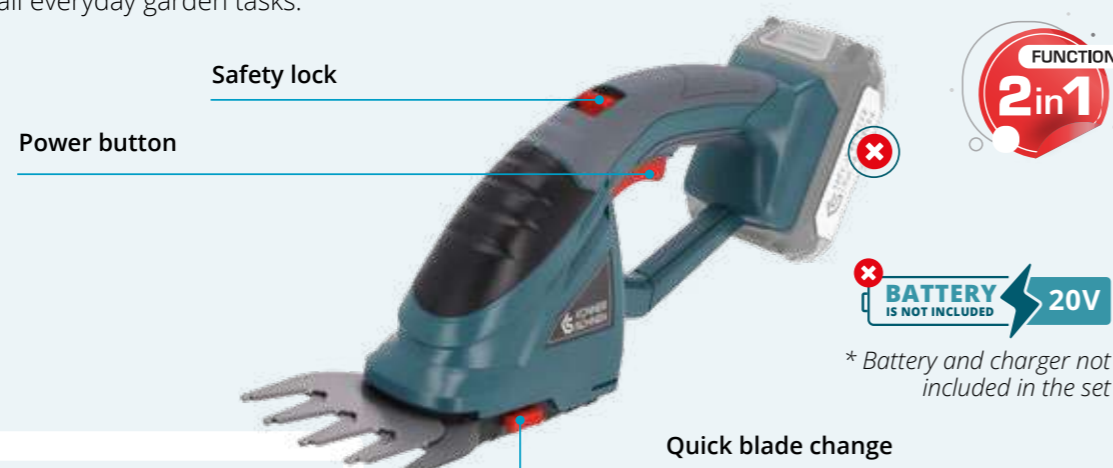

Rated voltage	DC 20 V
Battery capacity (not included)	2 - 8 Ah
Max cutting diameter	7,5 mm
Net weight	1,6 kg
EAN code	4 260405 368457



Double-sided blades

* Battery and charger not included in the set

POWER TO WIN



	KS SHT-8V	KS SHT-20V	KS HT-20V
Rated voltage	DC 8 V	DC 20 V	DC 20 V
Battery capacity (not included)	2000 mAh	2 - 8 Ah	2 - 8 Ah
Blade strokes no load	1100 strokes/min	1200 strokes/min	1550 strokes/min
Cutting length	120 mm (shrub blade) / 80 mm (grass blade)	199 mm (shrub blade) / 92 mm (grass blade)	22" (55 cm)
Max cutting diameter	7,5 mm	7,5 mm	16 mm
Gross dimensions (LxWxH)	307x94x130 mm	400x130x153 mm	930x220x200 mm
Net weight	1,0 kg	1,6 kg	2,5 kg
Gross weight	1,12 kg	1,82 kg	3,5 kg
EAN code	4 260405 368419	4 260405 368457	4 260405 367153

ACCESSORIES FOR THIS PRODUCT (sold separately)
page: 15, 101



EXTEND YOUR POSSIBILITIES

The **KS EP8** telescopic extension is a lightweight and functional accessory for the **SHT-8V** shears. The adjustable length from 53–83 cm allows ergonomic working positions, while the lock button and power switch increase safety. The rotation clamp makes it easy to adjust the working angle, and the two wheels ensure stable and precise tool control.

KS EP8

Length adjustment	53-83 cm
Mechanism	Folding and rotation
Additional elements	2 wheels, lock button (Lock-Off), power switch
Gross dimensions (LxWxH)	190x95x1060 mm
EAN code	4 260405 368464

The **KS EP20** telescopic extension is a practical accessory for the **SHT-20V** trimmer, increasing reach and convenience of use. Adjustable length from 56–89 cm and wheels make operation easier, while the folding mechanism, lock button, and power switch ensure safety and comfort.

KS EP20

Length adjustment	56-89 cm
Mechanism	Folding and rotation
Additional elements	2 wheels, lock button (Lock-Off), power switch
Gross dimensions (LxWxH)	190x95x1150 mm
EAN code	4 260405 368471



CORDLESS PRUNERS

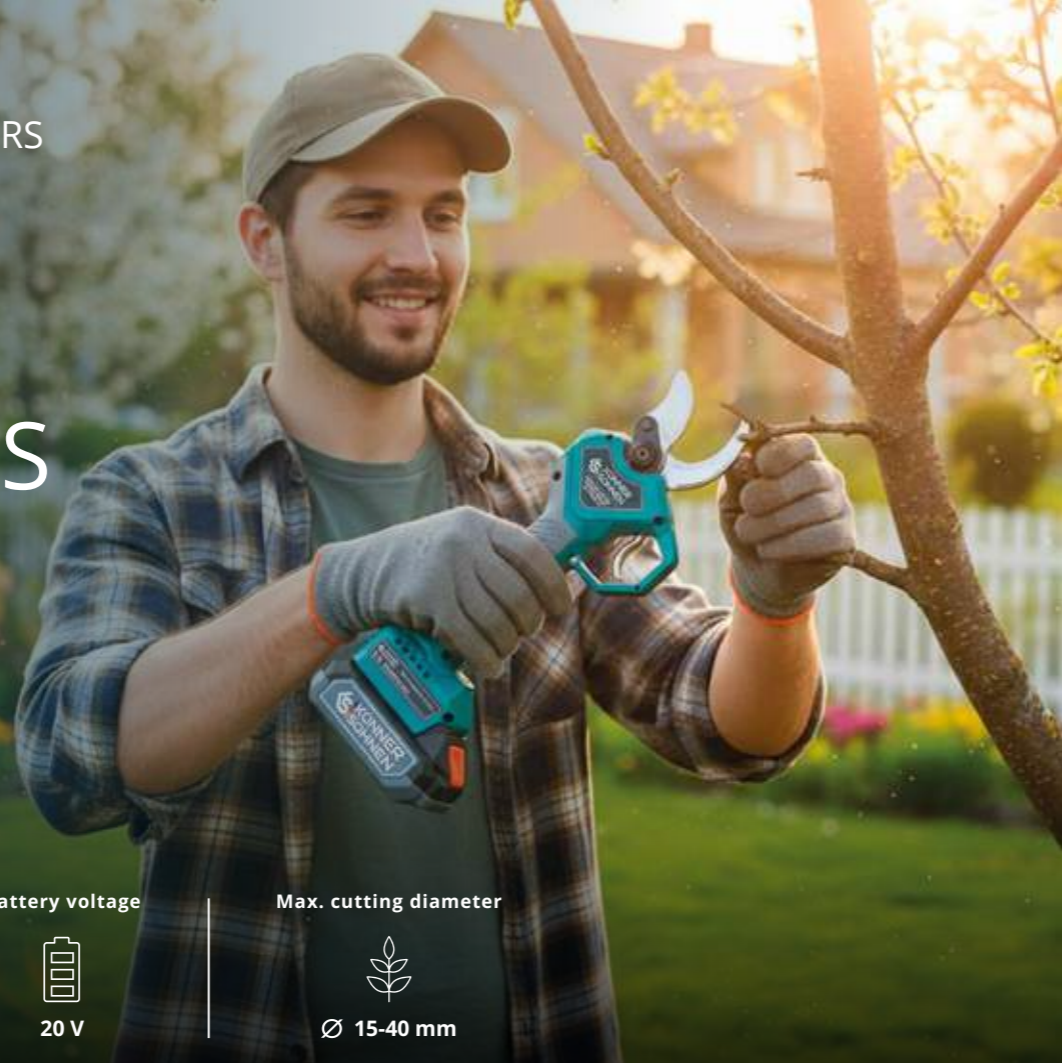

Battery voltage



20 V

Max. cutting diameter



Ø 15-40 mm

The **KS CSP20V-32** and **KS CSP20V-40** cordless pruners provide fast, precise, and safe cutting of branches in any garden. With **adjustable blade opening modes**, they adapt to branch thickness, saving energy and extending runtime. **SK5 carbon-steel blades** deliver clean cuts, while the **20 V battery system** ensures full mobility and instant readiness — no cables, no effort.

Set includes case, battery, and charger.



15 mm



25 mm



32 mm



40 mm

- ✔ **Perfectly clean cuts** – durable carbon steel blades ensure precision, long service life, and easy cutting, even on dry or hard branches.
- ✔ **Higher performance and reliability** – the brushless motor guarantees stable operation, long service life, and a comfortable low noise level.
- ✔ **Maximum comfort during work** – the ergonomic handle with rubber coating reduces fatigue, provides a secure grip, and enhances safety.
- ✔ **Convenient control and settings** – the intuitive panel allows quick mode selection and battery monitoring for uninterrupted operation.



BRUSHLESS MOTOR

RELIABLE BRUSHLESS MOTOR

The use of a brushless motor ensures high performance and long service life. This motor type features fewer moving parts requiring maintenance and provides low noise levels during operation.

TRADITIONELLE
DEUTSCHE
QUALITÄT



KS CPS20V-32

Compact and powerful, this pruner cuts branches up to **32 mm thick** with precision and ease.

The brushless motor ensures strong performance with minimal noise and vibration, while three **blade opening modes** (15, 25, 32 mm) save energy and extend battery life. Durable **SK5 steel blades** deliver clean cuts, and the ergonomic rubber handle provides a secure, comfortable grip.

INCLUDED ACCESSORIES for KS CSP20V-32:

spark plug wrench, wrench, blade protection cover, sharpening stone, and oil bottle.



* Battery and charger not included in the set

KS CPS20V-40

The Könnert & Söhne® **KS CSP20V-40** pruner gives you the power to work faster and safer. Its **brushless motor** delivers strong, consistent performance and lasts longer, while hardened steel blades make clean, effortless cuts up to **40 mm**. With **two cutting modes** (20 / 40 mm), **bare-hand detector** and **ergonomic rubber-coated grip** you can adapt to any branch thickness and save battery energy.

INCLUDED ACCESSORIES for KS CSP20V-40:

socket wrench, hex key (2.5/3/5 mm), sharpening stone, and oil bottle.



	KS CPS20V-32	KS CPS20V-40
Battery voltage	20 V	20 V
Motor	brushless	brushless
Max cutting diameter	32 mm	40 mm
Cutting diameter options	15/25/32 mm	20/40 mm
Number of modes	3	2
Blade material	SK5 steel	SK5 steel
Trigger material	plastic	metal
Net weight	0,9 kg	1 kg
EAN code	4 260405 368419	4 260405 366002

ACCESSORIES FOR THIS PRODUCT (sold separately)
page: 15, 101



For the KS CSP20V-32 CASE and KS CSP20V-40 CASE models,

the standard set additionally includes: a battery, a charger, and a storage case.

KS CSP20V-32 CASE
EAN code 4 260405 365500

KS CSP20V-40 CASE
EAN code 4 260405 368839



CORDLESS CHAINSAWS

MINI CHAINSAWS



Rated voltage



20 V

Guide bar length



8"/20", 12"/30"

Max. cutting diameter



Ø 100-150 mm

The KÖNNER & SÖHNEN® **KS MCS20V-8** and **MCS20V-12** mini chainsaws deliver quick, precise results for everyday garden and household tasks. A **powerful brushless motor**, **lightweight body**, and **compact design** ensure confident cutting performance - ideal for **pruning branches**, **preparing firewood**, or **small carpentry jobs**, even in tight or elevated areas.

KS MCS20V-8

Automatic chain lubrication ensures uninterrupted operation and extends tool life

Impressive performance - cuts much faster than comparable models, meaning more work in less time

Protective guard shields against debris and chain contact

Tool-free chain tensioning - quick chain adjustment without screwdrivers or wrenches

Belt loop prevents the tool from falling during work at height

Safety lock button prevents accidental activation for safe transport

Large protective hand guard - prevents injuries from branches or chain

* Battery and charger not included in the set



BRUSHLESS MOTOR

RELIABLE BRUSHLESS MOTOR

The use of a brushless motor ensures high performance and long service life. This motor type features fewer moving parts requiring maintenance and provides low noise levels during operation.

TRADITIONELLE DEUTSCHE QUALITÄT



KS MCS20V-12

Safety lock button for secure transport

Ergonomic rubberized grip ensures a firm and precise hold

Belt loop for safe work at height

Rotating handle allows cutting at different angles

Extra protective guard with emergency chain brake

Tool-free chain tensioning mechanism

Impressive performance - the saw works much faster than comparable models. This means you can complete more work in the same amount of time

Large protective guard - protects the hand from injury caused by branches or the chain

* Battery and charger not included in the set



PRODUCT AVAILABLE IN SEVERAL SET VERSIONS:

KS MCS20V-8 and MCS20V-12

Standard set: guide bar, chain, and chain cover.

MCS20V-12 SET

Extended set for longer and more comfortable operation:

- ✓ Battery and charger
- ✓ Additional guide bar and chain for continuous work

EAN code 4 260405 365036

KS MCS20V-8 CASE

Maximum comfort and storage convenience:

- ✓ Battery and charger
- ✓ Additional guide bar and chain for continuous work
- ✓ Practical case — tool always at hand

EAN code 4 260405 365050



KS MCS20V-8



KS MCS20V-12

	KS MCS20V-8	KS MCS20V-12
Battery voltage	20 V	20 V
Motor	brushless	brushless
Chain speed (m/s)	8	10
Chain pitch	1/4"LP	1/4"LP
Number of drive links	44	62
Guide bar length	8"/20 cm	12"/30 cm
Automatic chain lubrication	Yes	Yes
Tool-free chain tensioning	Yes	Yes
Weight without battery	1,3 kg	1,9 kg
EAN code	4 260405 365197	4 260405 364497

ACCESSORIES FOR THIS PRODUCT (sold separately)
page: 15, 59, 101





CORDLESS CHAINSAWS

CORDLESS CHAINSAWS

TRADITIONELLE
DEUTSCHE
QUALITÄT



Rated voltage



20 V/40 V

Guide bar length



12"/14"/16"

Chain speed



5,6 - 15 m/s

Operating speed



3000 - 8000 rpm

The **KS CS20V-12** with a **3000 rpm motor** is ideal for light pruning and maintenance, while the **KS CS40V-14** and **KS CS40V-16** feature **brushless motors (8000 rpm)** for demanding cuts.

Brushless technology means higher efficiency, less maintenance, and longer tool life.

✓ AUTOMATIC CHAIN LUBRICATION

An integrated pump supplies oil to the bar and chain during operation, ensuring smooth running, reduced wear, and a longer service life.

✓ TOOL-FREE CHAIN TENSIONING MECHANISM

Quickly adjust chain tension without tools. This convenient system improves cutting precision, prevents wear, and ensures safe operation.

Powered by **20 V lithium-ion batteries (2-8 Ah)**, K&S chainsaws offer **long runtime, fast charging, and minimal self-discharge**. Their compact, lightweight batteries make them easy to handle for extended use.

**Battery and charger not included in the set.*



RELIABLE BRUSHLESS MOTOR

The use of a brushless motor ensures high performance and long service life. This motor type features fewer moving parts requiring maintenance and provides low noise levels during operation.



- ✓ Tool-free chain tensioning mechanism for easy operation and maintenance
- ✓ Automatic lubrication system extends chain life
- ✓ Ergonomic non-slip rubber handle effectively reduces vibration and slippage
- ✓ Lightweight design for easy maneuverability in different cutting directions



	KS CS20V-12	KS CS40V-14	KS CS40V-16
Rated voltage	20 V	40 V (20 V+20 V)	40 V (20 V+20 V)
Battery capacity (not included)	2-8 Ah	2-8 Ah	2-8 Ah
Operating speed	3000 rpm	8000 rpm	8000 rpm
Guide bar length	12" (30 cm)	14" (35 cm)	16" (40 cm)
Motor type	brushed motor	brushless motor	brushless motor
Chain speed	5,6 m/s	15 m/s	15 m/s
Oil tank capacity	300 ml	250 ml	250 ml
Tool-free chain tensioning	+	+	+
Gross dimensions (L×W×H)	455×225×230 mm	455×220×255 mm	455×220×255 mm
Net weight	3,5 kg	3,6 kg	3,6 kg
Gross weight	4,2 kg	4,6 kg	4,6 kg
EAN code	4 260405 367061	4 260405 367078	4 260405 367450

ACCESSORIES FOR THIS PRODUCT (sold separately)
page: 15, 59, 101





CORDLESS LEAF VACUUM AND BLOWER



Rated voltage



40 V max

Max air volume



550 m³/h

Dust bag capacity



45 l

Max air speed



270 km/h

The Könnner & Söhnen® cordless leaf vacuum and blower makes cleaning your yard quick, easy, and cable-free. Equipped with **four working speeds and a Turbo mode**, it adapts to every task — from gentle leaf blowing to heavy debris collection. The built-in **mulching function** reduces waste and saves disposal time.

✓ EASY TO USE

A **tool-free quick-change system** lets you switch between vacuum and blower in seconds. Weighing only **3.5 kg**, it's compact, comfortable, and easy to handle. The **padded shoulder strap** distributes weight evenly, reducing fatigue during longer jobs.

✓ MOBILITY

Powered by **20 V lithium-ion batteries** (2–8 Ah), this blower works anywhere — even far from power outlets. The battery offers **long runtime**, fast charging, and is **compatible with all K&S cordless tools**, making it a smart addition to your collection.



3-IN-1 BLOWER | VACUUM | MULCHER

The Könnner & Söhnen® 3-in-1 cordless garden tool takes care of all key yard-cleaning tasks. In vacuum mode, it collects leaves, branches, dust, and small debris into a large 45 L collection bag. The built-in shredder performs effective mulching, reducing leaf volume by up to 10 times and turning waste into nutrient-rich material for the garden. Switch to blower mode to generate airspeeds of up to 270 km/h, quickly clearing leaves and dirt from lawns, patios, and walkways.



RELIABLE BRUSHLESS MOTOR

The use of a brushless motor ensures high performance and long service life. This motor type features fewer moving parts requiring maintenance and provides low noise levels during operation.



Intelligent control

Smart electronics adjust motor speed automatically. Change speed with one button for precise, efficient work.



* Battery and charger not included in the set

- ✓ Mulching function
- ✓ Tool-free quick-release air pipe with one button
- ✓ Intelligent control
- ✓ Single, quick-release carrying strap

KS LBV-40V

Rated voltage	40 V (20 V+20 V)
Battery capacity (not included)	2 - 8 Ah
Max working speed	16300 rpm
Max air speed	270 km/h
Max air volume	550 m³/h
Dust bag capacity	45 l
Speed settings	4 speeds + Turbo mode
Gross dimensions (L×W×H)	470×280×360 mm
Net weight	3,5 (V)/2,7 (B) kg
Gross weight	4,6 kg
EAN code	4260405367115

ACCESSORIES FOR THIS PRODUCT (sold separately) page: 15, 101



INCLUDED IN THE SET:

- Suction pipe
- Blowing pipe with built-in scraper
- Shoulder strap
- 45 L dust bag

GRASS



GRASS TRIMMERS



LAWN MOWERS



ELECTRIC GRASS TRIMMERS

POWERFUL. PRECISE.
EASY TO HANDLE.

Rated power



250 - 1400 W

Rated voltage



230 V/50 Hz

Cutting width



220 - 420 mm

Working speed



7000 - 12000 rpm

The **Könner & Söhnen® electric grass trimmer** is the ideal choice for **uneven terrain, slopes, and areas with many obstacles** such as shrubs and fences, when used in a **suspended position**, not on the ground. Powered directly from the mains, it operates without the need for recharging or refueling — offering continuous, uninterrupted performance.

HIGHLIGHTED FEATURES

- **Split shaft** for easy transport and compact storage
- **Triple-blade cutter and trimming line** for versatile work — from fine edging to thicker grass

KS GT-250

PORTABLE ELECTRIC GRASS TRIMMER

The **Könner & Söhnen® KS GT-250** is a **lightweight and highly maneuverable electric trimmer**, weighing only **1.22 kg** yet delivering an impressive **12,000 rpm** cutting speed. Designed for **mowing soft or young grass** in small areas, it's perfect for trimming along **path edges, flowerbeds, fences**, and other hard-to-reach spots. The **low-mounted motor** minimizes vibration on the handle, providing greater comfort and precise control during operation.

Rated voltage	230V
Line length	6 m
Cutting width	220 mm
Net weight	1.22 kg
EAN code	4 260405 367375



KS GT-450 MULTIFUNCTIONAL 2-IN-1 GRASS TRIMMER



Anti-slip handle with start lock button

Multi-position rotating handle



The KS GT-450 trimmer offers **two operating modes** – grass mowing and edging, making it a versatile tool for lawn care around the house.

Limiting frame extension

Automatic line feeding



Telescopic tube

Working head angle adjustment (6 positions)

Tilt adjustment lever

INCLUDED IN THE SET:
Spool with 2.5 m trimming line

VARIOUS FEATURES FOR USER COMFORT

✓ ADJUSTABLE ROTATING HANDLE

Allows precise handle positioning at any angle. Fixed securely on the tube with a **lock button or wing nut**, without the need for tools.

✓ TELESCOPIC TUBE

Quick, tool-free adjustment of length and position makes operation comfortable for users of any height.

✓ ADJUSTABLE MOTOR HOUSING

The motor head can be rotated along the tube to **switch between mowing and edging functions** or change the **working angle** for trimming around obstacles.

✓ EXTENDABLE LIMITING FRAME

Protects ornamental plants and garden borders by **preventing accidental cuts** while trimming close to them.

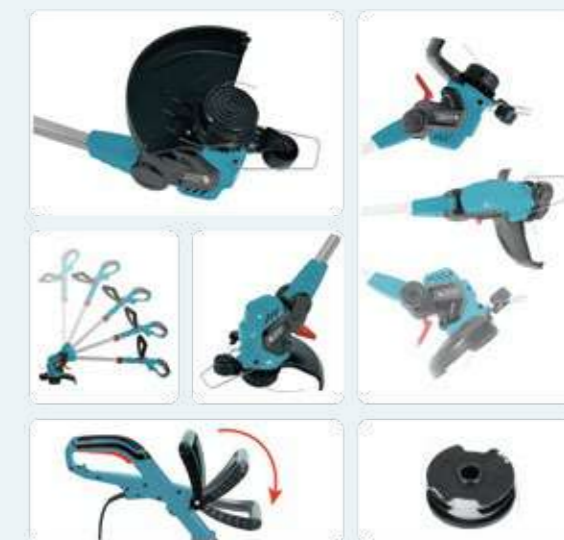



KS BCT-1400

The Könnert & Söhnen® **KS BCT-1400 electric trimmer** is a versatile and high-performance tool designed to handle everything from light grass trimming to dense vegetation. Powered by a **1400 W motor** and reaching **blade rotation speeds up to 7500 rpm**, it delivers efficient, consistent cutting across a wide range of conditions.

The top-mounted motor allows easy trimming of tall plants and effective mowing of even wet grass, making this trimmer a reliable all-season tool.

✔ EASY TO USE AND STORE

- **Ergonomic T-handle** for comfortable two-handed control — improves precision and speeds up work.
- **Padded shoulder strap** helps balance the tool's weight for long, fatigue-free operation.
- **Adjustable handle height** — adapts easily to the user's height.
- **Quick assembly and disassembly** for convenient transport and storage.

✔ USER SAFETY

- **Safety start button** prevents accidental activation.
- **Impact-resistant protective cover** shields the user from debris and rotating parts.

✔ EQUIPMENT PROTECTION

- **Built-in overload protection system** prevents motor damage during heavy or extended use — the trimmer automatically shuts off in case of overheating.
- **Short power cord** design reduces the risk of accidental cable damage during operation.

Könnert & Söhnen® Electric Grass Trimmers — smart power and precision for a perfect finish.



SET INCLUDES:

- Shoulder strap
- Three-blade cutting knife
- Head with 5 m trimming line



- Optional durable 255 mm blade (40 teeth) with tungsten carbide tips



POWER TO WIN



KS GT-250

KS GT-450

KS BCT-1400

Engine power	250 W	450 W	1400 W
Voltage	230 V	230 V	230 V
Engine type	Brush motor	Brush motor	Brush motor
Frequency	50 Hz	50 Hz	50 Hz
Speed (grass trimmer/blade)	12000 rpm	10000 rpm	7000 rpm/ 7500 rpm
Cutting diameter (grass trimmer/blade)	220 mm	280 mm	420 mm / 255 mm
Cutting thickness (grass trimmer)	1.2 mm	1.6 mm	1.6 mm
Gross dimensions (LxWxH)	195×120×400 mm	940×240×110 mm	940×260×130 mm
Net weight	1,2 kg	2,2 kg	4,5 kg
Gross weight	1,5 kg	2,9 kg	5,6 kg
EAN code	4 260405 367375	4 260405 368389	4 260405 367146





GASOLINE BRUSHCUTTER



Easy & quick engine start



CDI ignition system



Cruise Control



Convenient to transport



The Könnert & Söhnen® gasoline brush cutter series combines high performance, durability, and comfort, making it the perfect choice for both professional gardeners and maintenance of large green areas.

PERFORMANCE AND DESIGN

Available with **2-stroke** and **4-stroke engines** delivering **1.25–1.4 kW of power**, each trimmer is equipped with:

- A **split shaft** with an aluminium connector for easy storage and transport
- A **professional 4-point anti-vibration system** that minimizes hand fatigue
- An **E-Start** system and **Auto-Switch** for effortless starting
- **Cruise Control** to maintain steady speed without continuous throttle pressure

Built with high-quality components, these trimmers provide **comfortable, stable operation**, even during long work sessions in demanding conditions.

UNIVERSAL APPLICATION

The **interchangeable cutting tools** — **Tap&Go head** and **shrub blade** — make the trimmers suitable for both fine lawn care and tougher vegetation. The **tool-free replacement system** allows quick switching between attachments for different tasks.

EASE OF USE & WORK COMFORT

An **adjustable bicycle-type handlebar** and **ergonomic shoulder strap** ensure comfort even during prolonged operation. The handle's **height and rotation adjustment** let users adapt the tool to their height and preferences. The **split shaft** design simplifies transport and storage, even in tight spaces or a car trunk.

SAFETY & DURABILITY

Modern **low-emission engines** ensure reduced environmental impact and long service life. **Protective covers** shield the operator from debris, while the use of **durable materials** guarantees consistent performance under intensive use.



These trimmers feature powerful engines compliant with EURO 5 emission standards, offering reduced fuel consumption and low exhaust emissions.

CRUISE CONTROL — MAXIMUM COMFORT DURING OPERATION

The **cruise control function** allows you to set and maintain the desired working speed, relieving pressure on your fingers and wrists. This feature is especially useful during prolonged mowing of large areas, eliminating the need to constantly hold the throttle lever. The result is **smoother operation, reduced fatigue**, and greater **precision and comfort** during extended work sessions.

ROTATABLE BICYCLE-TYPE HANDLEBAR — ADJUSTMENT TO ANY HEIGHT AND CONDITIONS

The **adjustable bicycle-style handlebar** can be rotated and fixed at the most comfortable angle for each user and terrain type. It ensures **precise control and steady grip**, even during long mowing sessions. A **solid locking mechanism** provides stability, while the wide adjustment range improves **ergonomics and ease of use** — essential for professional, daily operation.

CDI IGNITION SYSTEM — RELIABLE START AND SMOOTH PERFORMANCE

Ensures **stable ignition**, improves overall engine responsiveness, and contributes to **lower fuel consumption**.

The Könnert & Söhnen® gasoline grass trimmers are built for **demanding users** who value **power, comfort, and reliability**. A solid construction and the use of **high-quality materials** guarantee a **long service life**, even under intensive use and challenging conditions.

KS BC17G-2T

This Könnert & Söhnen® gasoline brush cutter features easy E-Start, CDI ignition, and cruise control for smooth, stable operation. The ergonomic bike handle adjusts quickly without tools, rotates 90° for compact storage, and minimizes fatigue during long work sessions. A reinforced housing improves cooling and protects the engine from dirt.

- **Two-Stroke Engine** - delivers high performance and effective mowing while meeting **EURO 5 emission standards**. Designed for stable operation and optimal fuel efficiency.

Engine power	1.7 HP at 6500 rpm/ 1.25 kW
Engine displacement	42,7 cm³
Gross dimensions	1050x280x293x80 mm
Net weight	7,5 kg
EAN code	4 260405 368488

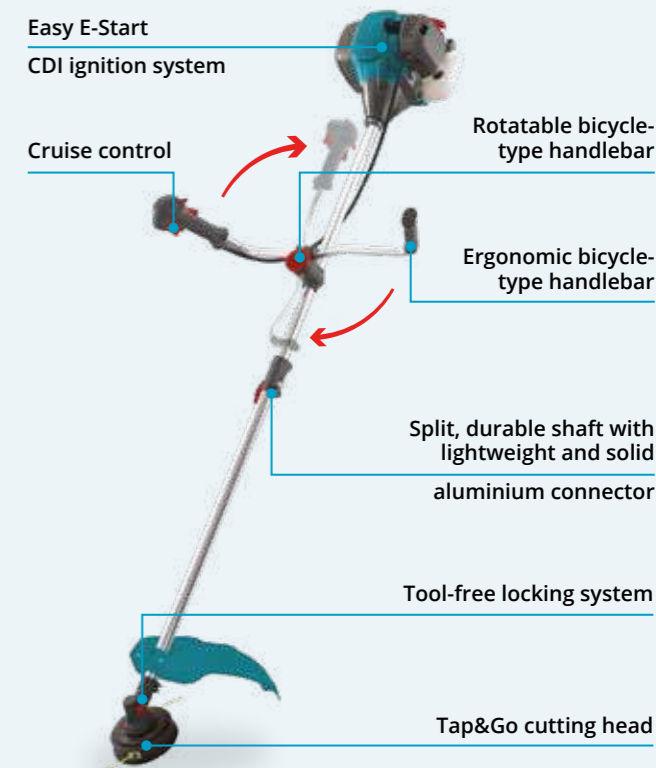



KS BC19G-2T

The Könner & Söhnen® KS BC19G-2T brush cutter combines power and comfort with a fuel-efficient Euro 5 engine and CDI ignition for stable performance.

E-Start, anti-vibration system, and a bike handle ensure easy, comfortable use, while the split shaft, cruise control, and Tap&Go line feed simplify operation and storage.

✔ **Two-Stroke Engine** - delivers high performance and effective mowing while meeting **EURO 5 emission standards**. Designed for stable operation and optimal fuel efficiency.

Engine power	1.9 HP at 6500 rpm / 1.4 kW
Engine displacement	51,7 cm³
Gross dimensions	1050x280x293x80 mm
Net weight	7,5 kg
EAN code	4 260405 368501

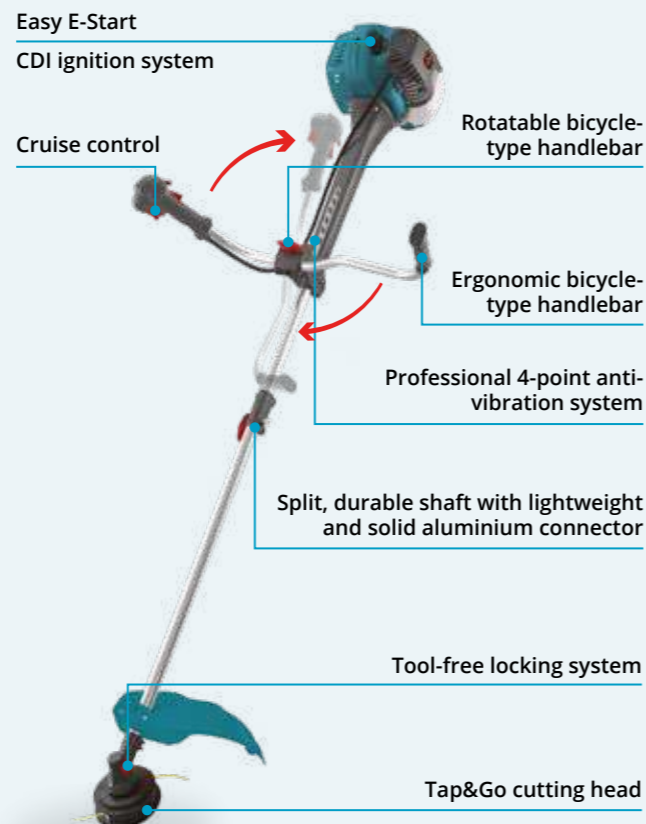

KS BC16G-4T

The Könner & Söhnen® gasoline brush cutter is a powerful, reliable 4-stroke tool for maintaining gardens and parks. It features CDI ignition, an adjustable bike handle, and a 4-point anti-vibration system for stable, comfortable operation. The detachable shaft, cruise control, and tool-free locking ensure easy use and transport.

Includes a backpack strap, bush blade, and Tap&Go head.

✔ **Four-Stroke Engine** — Provides fuel savings, quiet and smooth operation, and reduced vibration and exhaust emissions, ensuring a longer service life and greater user comfort.

Engine power	1.63 HP at 7000 rpm / 1.2 kW
Engine displacement	38,9 cm³
Gross dimensions	1050x280x293x80 mm
Net weight	7,5 kg
EAN code	4 260405 368495

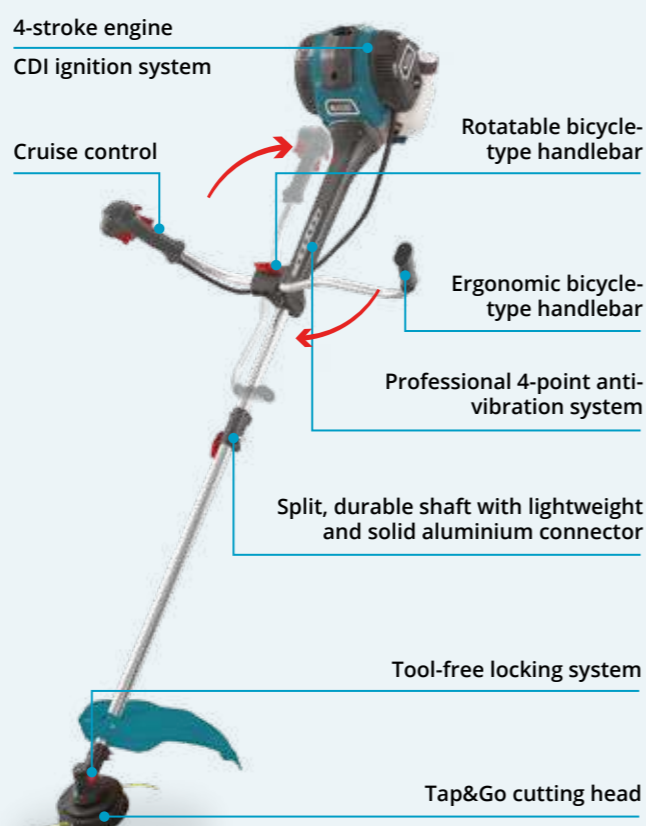

GASOLINE BRUSHCUTTER



	KS BC17G-2T	KS BC19G-2T	KS BC16G-4T
Engine type	2-stroke	2-stroke	4-stroke
Cylinder diameter	40 mm	44 mm	40 mm
Engine power	1.7 HP at 6500 rpm / 1.25 kW	1.9 HP at 6500 rpm / 1.4 kW	1.63 HP at 7000 rpm / 1.2 kW
Engine displacement	42,7 cm ³	51,7 cm ³	38,9 cm ³
Max engine speed	9500 rpm	9500 rpm	9500 rpm
Engine model	KS 45	KS 55	KS 40
Max cutting width	420 mm	420 mm	420 mm
Tri-blade diameter	255 mm	255 mm	255 mm
Trimmer line diameter	up to 2,4 mm	up to 2,4 mm	up to 2,4 mm
Fuel tank capacity	1100 ml	1100 ml	1100 ml
Shaft diameter	28 mm	28 mm	28 mm
Split shaft	+	+	+
Mounting type	side	side	side
Gross dimensions (LxWxH)	1050x280x293x80 mm	1050x280x293x80 mm	1050x280x293x80 mm
Net weight	7,5 kg	7,5 kg	7,5 kg
EAN code	4 260405 368488	4 260405 368501	4 260405 368495

ACCESSORIES FOR THIS PRODUCT (sold separately)
page: 59, 100, 101



INCLUDED IN THE SET:

- Upgraded backpack harness
- Brush cutter blade Ø255 mm
- Face shield and ear protectors
- Tool bag





ELECTRIC LAWNMOWERS



Rated power



1000-1800 W

Voltage



230 V/50 Hz

Cutting width



320-420 mm

Cutting height



25-80 mm

Könnér & Söhnen® electric lawnmowers deliver maximum efficiency without the need to stop for charging or refueling. Equipped with **powerful motors up to 1800 W** and operating speeds of **3000–3450 rpm**, they ensure smooth, precise mowing — from neatly trimmed lawns to tougher vegetation.

✓ PERFORMANCE AND DESIGN

The **K&S electric mower lineup** offers models for every need — from compact, lightweight units for small gardens to more robust machines for demanding tasks. All mowers feature a **durable, well-balanced design** that ensures stability and easy maneuvering on different terrains. Each detail is engineered for comfort, reliability, and long service life.

✓ ADJUSTABLE CUTTING HEIGHT (25–80 MM)

Easily set your preferred height using a convenient lever with 3 or 5 positions (depending on the model).

✓ EASY TO USE AND STORE

Ergonomic handles with height adjustment (KS 38LM, KS 42LM), single-hand cable clamp, and foldable frame for compact storage. Selected models feature a **silicone foam handle cover** for a secure, comfortable grip.

✓ TOOL-FREE ASSEMBLY

Simple structure allows for quick setup, folding, and maintenance without tools.

✓ GRASS CATCHER

Lightweight, durable containers hold **40–50 liters** of grass clippings and feature a **fill level indicator**. Combination plastic-fabric construction (except KS 32LM) keeps the mower light and easy to handle. Model **KS 32LM** includes a fully plastic catcher — sun-resistant, washable, and easy to empty.

✓ BRUSHLESS MOTOR

Model **KS 38LM-BL** features a **brushless motor** that ensures high efficiency, longer service life, and lower noise levels. With fewer moving parts, it requires minimal maintenance and delivers stable, quiet operation.

✓ MULCHING FUNCTION

The **KS 42LM** model includes a **mulching system** that finely chops and redistributes grass clippings across the lawn. This natural fertilizer enriches the soil and improves lawn health, while the **42 cm cutting width** allows for efficient mowing and mulching even on large areas.

TRADITIONELLE
DEUTSCHE
QUALITÄT

- ✓ Excellent maneuverability thanks to balanced weight
- ✓ Low vibration level
- ✓ Tool-free assembly
- ✓ Compact storage



KS 32LM



KS 38LM



KS 38LM-BL



KS 42LM

	KS 32LM	KS 38LM	KS 38LM-BL	KS 42LM
Rated voltage	230 V	230 V	230 V	230 V
Frequency	50 Hz	50 Hz	50 Hz	50 Hz
Rated power	1000 W	1400 W	1400 W	1800 W
Working speed	3450 rpm	3250 rpm	3000 rpm	3250 rpm
Cutting width	320 mm	380 mm	380 mm	420 mm
Cutting height	25-45-65 (3 pos.)	25-75 (5 pos.)	25-65 (5 pos.)	25-80 (5 pos.)
Grass catcher	25 l	40 l	50 l	40 l
Mulching function	-	-	-	+
Front/rear wheels	5,5"	6,0"/8,0"	6,0"/7,0"	6,0"/9,0"
Handle adjustment	-	+	-	+
Dimensions (L×W×H)	590x380x290 mm	700x470x335 mm	660x440x335 mm	720x470x365 mm
Net weight	6,8 kg	11,6 kg	16,7 kg	12,6 kg
Gross weight	8 kg	13,8 kg	17,8 kg	13,9 kg
EAN code	4 260405 367009	4 260405 367030	4 260405 367016	4 260405 367023

ACCESSORIES FOR THIS PRODUCT (sold separately)
page: 101



WOOD



CHAINSAWS



AXE



LOG SPLITTERS



**WOOD
CHIPPERS**

ELECTRIC CHAINSAWS

Rated power



1800 - 2400 W

Operating voltage



230 V/50 Hz

Guide bar length

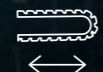

14"/16"/18"

Chain speed



13 - 15 m/s

Könner & Söhnen® electric chainsaws deliver high, uninterrupted performance without the need for recharging or refueling — ideal for long, demanding cutting sessions.

Lightweight and compact, K&S chainsaws ensure excellent maneuverability and control, even in confined spaces. They produce **no harmful emissions**, making them suitable for **indoor or semi-enclosed use**.

✓ AUTOMATIC CHAIN LUBRICATION

An integrated pump continuously oils the bar and chain for smooth operation, reduced wear, and a longer service life.

✓ TOOL-FREE CHAIN TENSIONING

Easily adjust chain tension in seconds — no tools needed. Ensures safer handling, optimal cutting performance, and prevents premature wear.

✓ SOFT START SYSTEM

Gradually accelerates chain speed for a smooth, controlled start. Prevents overload and provides extra comfort during operation.

✓ MAXIMUM PROTECTION

A **double safety guard** automatically cuts power in emergencies, while a **power button lock** prevents accidental activation.



HIGH-POWER MOTORS UP TO 2400 W

Durable and efficient electric motors deliver up to 2400 W of output power and a chain speed of 13–15 m/s, enabling fast, clean cuts and high productivity. Reliable, low-noise, and emission-free - built for consistent performance and long service life.

TRADITIONELLE
DEUTSCHE
QUALITÄT

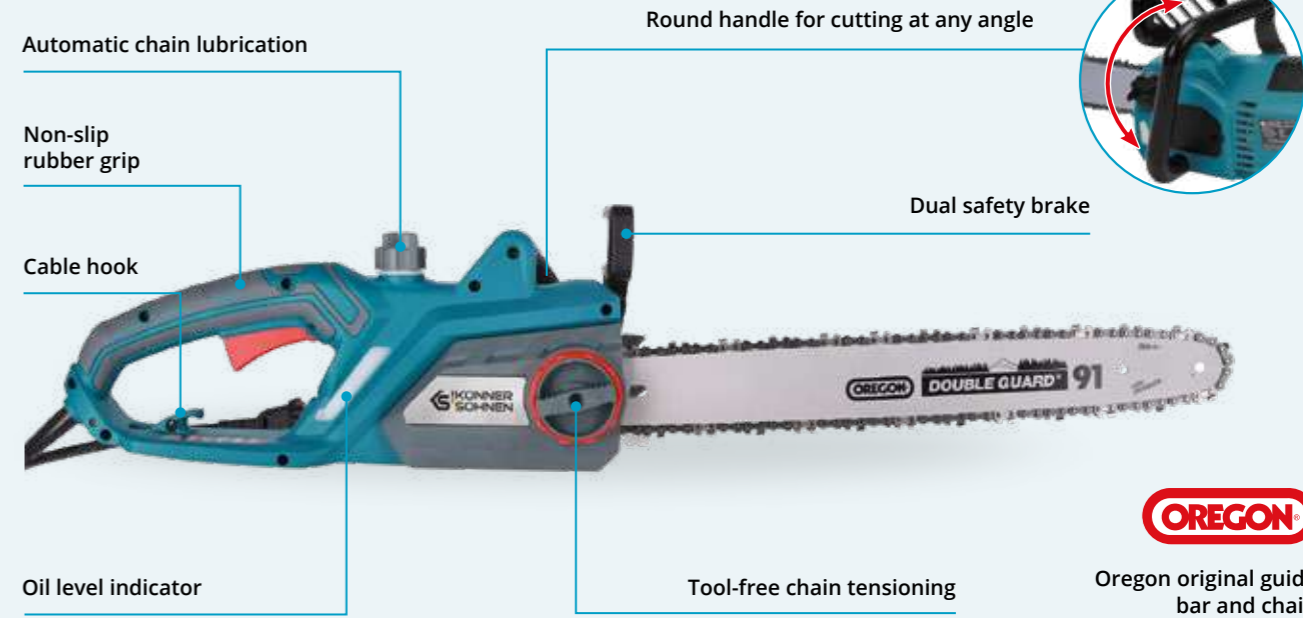

- ✓ High chain speed (up to 15 m/s) ensures better cutting performance
- ✓ Ergonomic non-slip rubber grip effectively reduces vibration and slippage
- ✓ Lightweight design for easy maneuverability in different cutting directions



	KS CS1800-14	KS CS2200-16	KS CS2400-18
Rated power	1800 W	2200 W	2400 W
Operating voltage	230 V	230 V	230 V
Frequency	50 Hz	50 Hz	50 Hz
Guide bar length	14" (35 cm)	16" (40 cm)	18" (45 cm)
Chain pitch	3/8"	3/8"	3/8"
Chain gauge	0.043" (1,1 mm)	0.050" (1,3 mm)	0.050" (1,3 mm)
Chain speed	15 m/s	14 m/s	13 m/s
Oil tank capacity	280 ml	140 ml	190 ml
Dual safety brake	+	+	+
Tool-free chain tensioning	+	+	+
Soft start	-	+	+
Overload protection	-	+	+
Gross dimensions (L×W×H)	500×285×200 mm	545×225×255 mm	510×265×200 mm
Net weight	4,7 kg	5,2 kg	5,7 kg
Gross weight	5,4 kg	5,9 kg	6,3 kg
Product code	4 260405 367085	4 260405 367108	4 260405 367092

ACCESSORIES FOR THIS PRODUCT (sold separately)
page: 59, 101



GASOLINE CHAINSAWS

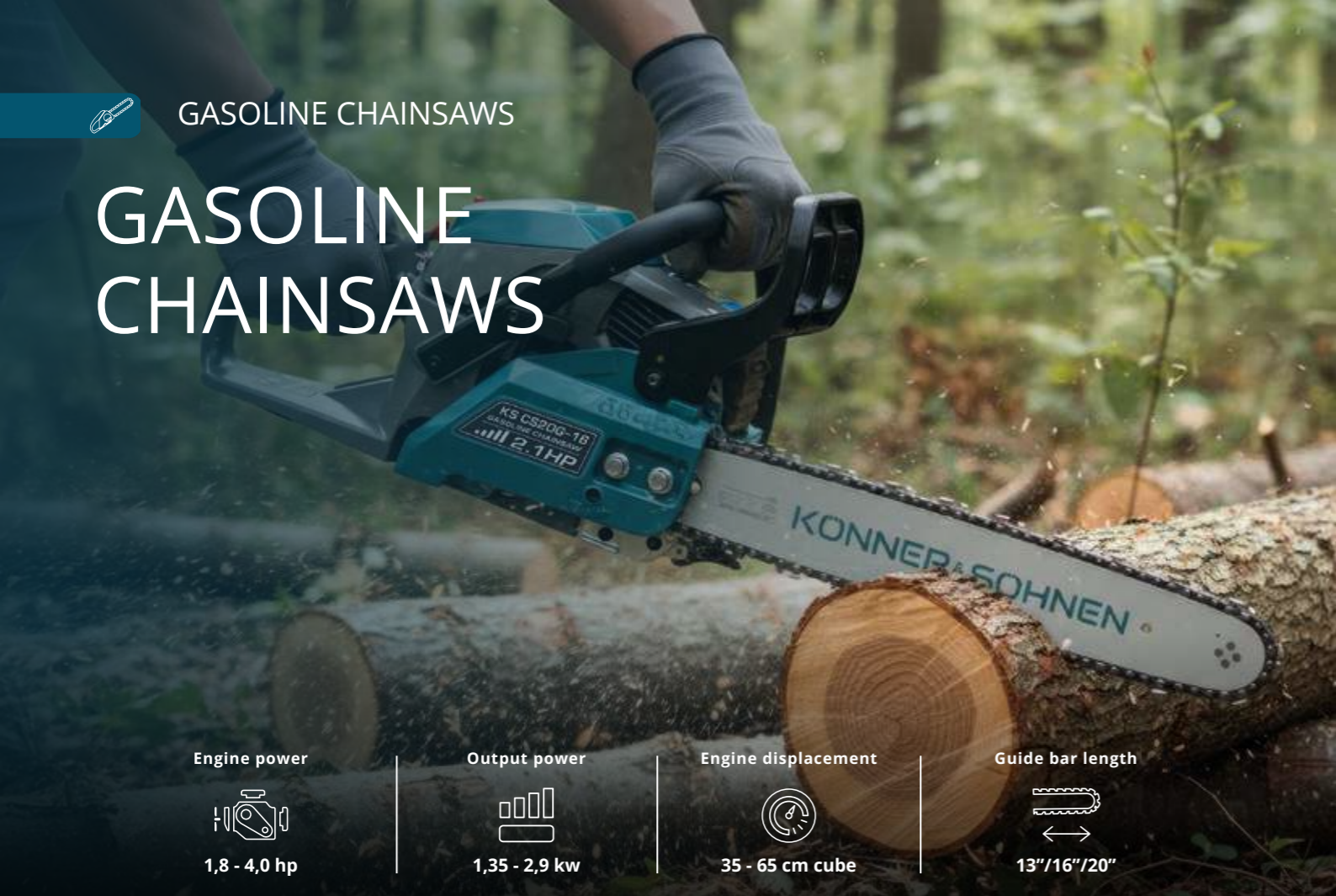

Engine power



1,8 - 4,0 hp

Output power



1,35 - 2,9 kw

Engine displacement



35 - 65 cm cube

Guide bar length

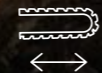

13"/16"/20"

Könner & Söhnen® gasoline chainsaws combine high performance, durability, and complete independence from external power sources. They are ideal for both professional forestry work and domestic use — built to handle **any type of wood**, including raw logs.

Equipped with **Walbro carburetors** and **Bosch ignition spark plugs**, these chainsaws deliver stable, efficient operation and long service life.

✓ HIGH-PERFORMANCE ENGINES

Durable, wear-resistant engines with a **four-channel fuel intake system** ensure efficient combustion, maximum power output, and reduced emissions. The **chromium-plated cylinder** increases resistance to heavy loads and high temperatures, extending engine life.

✓ AUTOMATIC CHAIN LUBRICATION

A built-in oil pump evenly distributes lubricant to the bar and chain for smooth, consistent operation. Oil flow control optimizes consumption depending on the cutting task and bar length.



Safety is a top priority for **Könner & Söhnen®**. All gasoline chainsaws feature an **inertia brake** that instantly stops the chain in emergencies, **chain catchers** that prevent rebound, and a **throttle lock** that eliminates accidental activation.

✓ EASY START SYSTEM

Simplifies engine ignition and reduces pull force — for smooth, reliable starts in all weather conditions.

✓ SIDE CHAIN TENSIONING

Allows quick and safe chain adjustment from the side of the housing — no need to disassemble or use extra tools.



HIGH-PERFORMANCE ENGINE WITH CHROMIUM-PLATED CYLINDER

Reduces wear, withstands heavy loads and extreme temperatures. The four-channel fuel intake system ensures maximum engine efficiency.



Chromium-plated coating

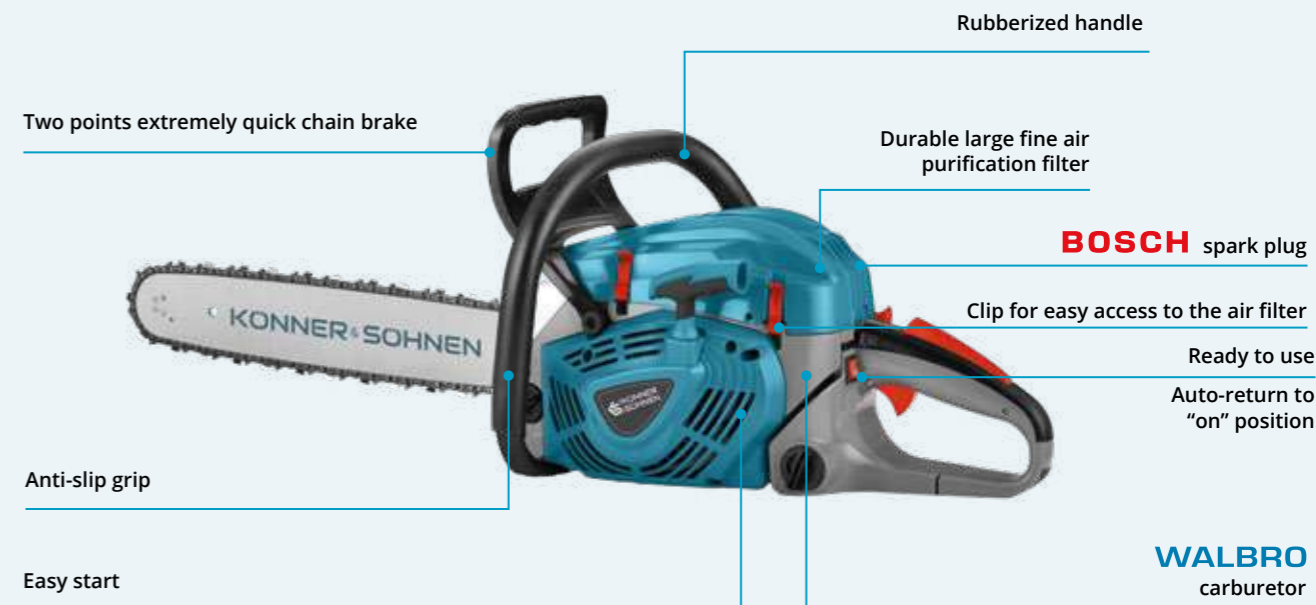

SPARK PLUG BOSCH



Bosch spark plugs deliver a strong, stable spark in all conditions, ensuring **easy starting**, **smooth operation**, and **consistent engine performance**.

A **quick-release cover with latches** provides fast access to the air filter and spark plug for effortless maintenance.

✓ JAPANESE WALBRO CARBURETOR

Used in **KS CS31G**, **KS CS40G-20** models, the **Walbro carburetor** precisely regulates fuel supply for **optimal combustion** and **excellent fuel efficiency**, reducing operating costs while maintaining maximum power.

✓ PAPER AIR FILTER

In **KS CS31G** models, the enlarged **paper filter** offers superior air filtration compared to nylon filters.

Its larger surface area ensures **optimal airflow**, improving engine efficiency and extending service intervals.

✓ WATERPROOF NYLON FILTER

In **KS CS21G** models, the **nylon filter** is moisture- and impact-resistant, **washable with water**, and provides reliable protection against dust and dirt — guaranteeing **stable operation** and **longer engine life**.



KS CS18G-14C

KS CS18G-14C gasoline chainsaw is a **compact yet powerful solution** for everyday home and garden work. A **chrome-plated cylinder** extends engine life, while **Summer/Winter modes** ensure easy starting in any weather. Safety and comfort are enhanced by the **inertia brake, Auto STOP/START, tool-free chain tensioning**, and an ergonomic handle for confident, fatigue-free operation.



KS CS20G-16

KS CS20G-16 gasoline chainsaw (2.1 HP, 1.6 kW, 16" guide bar) is a **compact and reliable tool** for garden and household work. A **chrome-plated cylinder** ensures durability, while **Summer/Winter mode, the EASY START system, primer, and auto STOP function** guarantee quick starting, safe operation, and maximum convenience in any conditions.



KS CS18G-14C



KS CS20G-16

Engine power	1,8 hp/1,35 kW	2,1 hp/1,6 kW
Engine displacement	35 cm ³	40 cm ³
Max engine speed	13000 rpm	13000 rpm
Idle speed	3000 rpm	3000 rpm
Fuel tank capacity	310 ml	310 ml
Chain lubrication system	automatic pump with regulator	automatic pump with regulator
Chain tensioning	tool-free	side adjustment
Oil tank capacity	210ml	210ml
Guide bar length	14" (35 cm)	16" (40 cm)
Chain pitch	LP 3/8"	LP 3/8"
Chain gauge	0,05" (1,3 mm)	0,05" (1,3 mm)
Net weight	4,8 kg	4,8 kg
EAN code	4 260405 364 183	4 260405 365029

ACCESSORIES FOR THIS PRODUCT (sold separately)
page: 59, 100, 101



CHOOSE YOUR GUIDE BAR AND CHAIN

Now you can customize your **Könner & Söhnen®** chainsaw to match your needs. Choose the optimal guide bar length and preferred brand — K&S or Oregon® — for the perfect balance of performance, comfort, and cutting precision. **Find your ideal setup for maximum efficiency.**



OR



13" | 33 cm 16" | 40 cm 18" | 45 cm 20" | 50 cm



KS CS21G-13



KS CS21G-16



KS CS21G-16-1

Engine displacement	45 cm ³		
Max engine power	2.1 HP/1.6 kW at 8500 rpm		
Max engine speed	11500 ± 500 rpm		
Idle speed	3000 ± 300 rpm		
Carburetor	HUALONG - MC16		
Fuel tank capacity	550 ml		
Fuel/oil mix ratio	40:1		
Oil tank capacity	260 ml		
Chain lubrication system	automatic pump with regulator		
Guide bar length	13" (33 cm)	16" (40 cm)	16" (40 cm)
Guide bar & chain brand	K&S	K&S	Oregon
Chain pitch	0,325" (8,25 mm)		
Chain gauge	0,058" (1,5 mm)		
Gross dimensions (L×W×H)	430×255×300 mm		
Net weight	5,6 kg		
Gross weight	7,5 kg		
EAN codes	4 260405 367986	4 260405 367979	4 260405 367962

ACCESSORIES FOR THIS PRODUCT (sold separately)
page: 59, 100, 101





GASOLINE CHAINSAWS

TRADITIONELLE
DEUTSCHE
QUALITÄT



Engine displacement	54,5 cm ³					
Max engine power	3.1 HP/2.3 kW at 8500 rpm					
Max engine speed	11000 ± 500 rpm					
Idle speed	3000 ± 300 rpm					
Carburetor	WALBRO - WT-966					
Fuel tank capacity	550 ml					
Fuel/oil mix ratio	40:1					
Oil tank capacity	260 ml					
Chain lubrication system	automatic pump with regulator					
Guide bar length	16" (40 cm)	16" (40 cm)	18" (45 cm)	18" (45 cm)	20" (50 cm)	20" (50 cm)
Guide bar and chain	K&S	Oregon	K&S	Oregon	K&S	Oregon
Chain pitch	0,325" (8,25 mm)					
Chain gauge	0,058" (1,5 mm)					
Gross dimensions (L×W×H)	505×255×300 mm					
Net weight	5,6 kg					
Gross weight	7,5 kg					
EAN codes	4 260405 367955 4 260405 367924 4 260405 367948 4 260405 367917 4 260405 367931 4 260405 367900					

ACCESSORIES FOR THIS PRODUCT (sold separately)
page: 59, 100, 101



KS CS40G-20

The **Könner & Söhnen® KS CS40G-20** gasoline chainsaw combines **professional-grade power** with **user comfort and safety**. Equipped with a **65 cm³ / 4.0 HP engine** and a **20" (50 cm) guide bar**, it effortlessly handles hardwood cutting, storm cleanup, and agricultural work.

Designed for convenience, the KS CS40G-20 includes **automatic chain lubrication**, **internal clutch**, **side adjustable chain tension** and **easy-start system** that ensures smooth ignition even after long storage periods.

An **anti-vibration system** and advanced **safety mechanisms** make operation comfortable and secure, while **German-engineered reliability** guarantees durability and simple maintenance.



Engine displacement	65 cm ³
Max engine power	4 hp/2.9 kW
Max engine speed	11500±500 rpm
Idle speed	3000±300 rpm
Fuel tank capacity	550 ml
Oil tank capacity	260 ml
Guide bar length (on request)	20" (50 cm)
Net weight	5,7 kg
EAN code	4 260405 368983

- ✓ High-performance 65 cm³ two-stroke engine
- ✓ 20" (50 cm) guide bar for universal applications
- ✓ Chain brake with instant activation
- ✓ Anti-vibration system
- ✓ Easy start
- ✓ Automatic chain lubrication
- ✓ Euro 5 compliant

ACCESSORIES FOR THIS PRODUCT (sold separately)
page: 59, 100, 101





CHAINSAW GUIDE BAR

The **Könner & Söhnen® chainsaw guide bar** is designed for versatile use — from firewood preparation and garden maintenance to tree pruning and construction work. Built from **three welded steel plates**, the bar's reinforced center slot provides excellent stability, while its simple design allows for **quick, tool-free installation**. Made from **high-quality, hardened materials**, it ensures reliable, long-lasting performance.



- ✓ Suitable for professional and home use
- ✓ Guide bar surfaces hardened by high-frequency current for extra durability

					EAN code
KS 138THK095	13" (33 cm)	0,058" (1,5 mm)	10	0,325	4260405367856
KS 168THBK095	16" (40 cm)	0,058" (1,5 mm)	10	0,325	4260405367849
KS 188THK095	18" (45 cm)	0,058" (1,5 mm)	10	0,325	4260405367832
KS 208WHBK095	20" (50 cm)	0,058" (1,5 mm)	12	0,325	4260405367825

CHAINSAW CHAIN

Könner & Söhnen® cutting chains are made from high-quality **chrome-nickel steel** using advanced manufacturing technology. Designed for **professional use**, they deliver fast, smooth cutting in both **soft and hard wood**.

The **long cutting tooth shape** ensures efficient performance, while a **hard chrome coating** increases wear resistance and extends service life.

- ✓ Super-efficient cutting tooth design
- ✓ Suitable for professional applications
- ✓ German steel 68CrNiMo — durable even at low temperatures
- ✓ Hardened rivets reinforce link connections
- ✓ Smooth, low-vibration cutting with minimal kickback
- ✓ Oil-retaining hole for enhanced chain lubrication



						EAN code
KS 28FC56	13" (33 cm)	0,325	1,5 mm	56	Full "chisel" tooth	4260405367894
KS 28FC66	16" (40 cm)	0,325	1,5 mm	66	Full "chisel" tooth	4260405367887
KS 28FC72	18" (45 cm)	0,325	1,5 mm	72	Full "chisel" tooth	4260405367870
KS 28FC78	20" (50 cm)	0,325	1,5 mm	78	Full "chisel" tooth	4260405367863



CHAINSAW OILS

Könner & Söhnen® chainsaw oils provide excellent lubrication and reliable protection for all two-stroke engines.

Their low-ash formulation keeps engine components clean, prevents deposits, and extends tool life.

- ✓ Ensures smooth operation and reduces wear
- ✓ Mixes easily with gasoline for convenient use
- ✓ Prevents rust and corrosion
- ✓ Extends the service life of the guide bar, chain, and sprockets
- ✓ Suitable for most two-stroke engines

Shelf life: 5 years | Made in Ukraine

Specifications: API: TC | JASO: FC | ISO: L-EGC



CHAIN LUBRICATION OIL

The **all-season Könner & Söhnen® chain oil** minimizes friction, protects against corrosion, and extends the service life of both the **chain and guide bar**. It ensures **stable performance in any weather** and is compatible with **all chainsaw types**.

KS BAR+CHAIN OIL

Capacity	1 l
Seasonality	all-season
Suitable for	all types of chainsaws
EAN code	4 260405 368273



TWO-STROKE ENGINE OIL

Premium semi-synthetic, low-ash Könner & Söhnen® oil for air-cooled two-stroke engines provides excellent lubrication and dependable protection. It significantly **extends engine life** and ensures **long-lasting, trouble-free performance** of your equipment.

KS 2T OIL

Capacity	1 l
Fuel-to-oil ratio	40:1
Quality standards	API: TC, JASO: FC, ISO: L-EGC
EAN code	4 260405 368280





AXE



UNIVERSAL AXE

The **Könner & Söhnen® universal axe** is built for versatility — ideal for **firewood preparation, wood processing, construction, and outdoor use**. Its **hardened carbon steel blade** with a **PTFE anti-corrosion coating** ensures long-lasting sharpness and protection against rust.

The **lightweight fiberglass handle** provides excellent force transfer and reduces fatigue.

An **ergonomic, shock-absorbing insert** minimizes vibration, while the **anti-slip coating** guarantees a firm grip in any weather.

Durable, well-balanced, and comfortable to use, it's also perfect for **camping, hiking, and field work**.

- ✔ Hardened and tempered carbon steel blade
- ✔ Well-balanced for efficient power transfer
- ✔ Lightweight fiberglass handle designed for easy carrying and effective wood chopping
- ✔ Ergonomic handle with shock absorber reduces vibration
- ✔ Blade with PTFE coating prevents corrosion and rust
- ✔ Durable handle with anti-slip coating



- Sharpening angle: 30°
- Anti-slip handle
- Plastic cover



	KS CA640	KS CA950	KS CA1250	KS CA1500
Axe length	355 mm	445 mm	600 mm	710 mm
Axe weight	640 g	950 g	1250 g	1500 g
Edge angle	30°	30°	30°	30°
EAN code	4 260405 367382	4 260405 367399	4 260405 367405	4 260405 367412

Multifunctional sharpener with anti-slip rubber feet ensures convenient and safe sharpening.

SHARPENER FOR AXES AND KNIVES

- ✔ Ceramic sharpening roller
- ✔ ABS durable housing

KS MS1	
Sharpener	1 pc
EAN code	4 260405 367443





LOG SPLITTERS

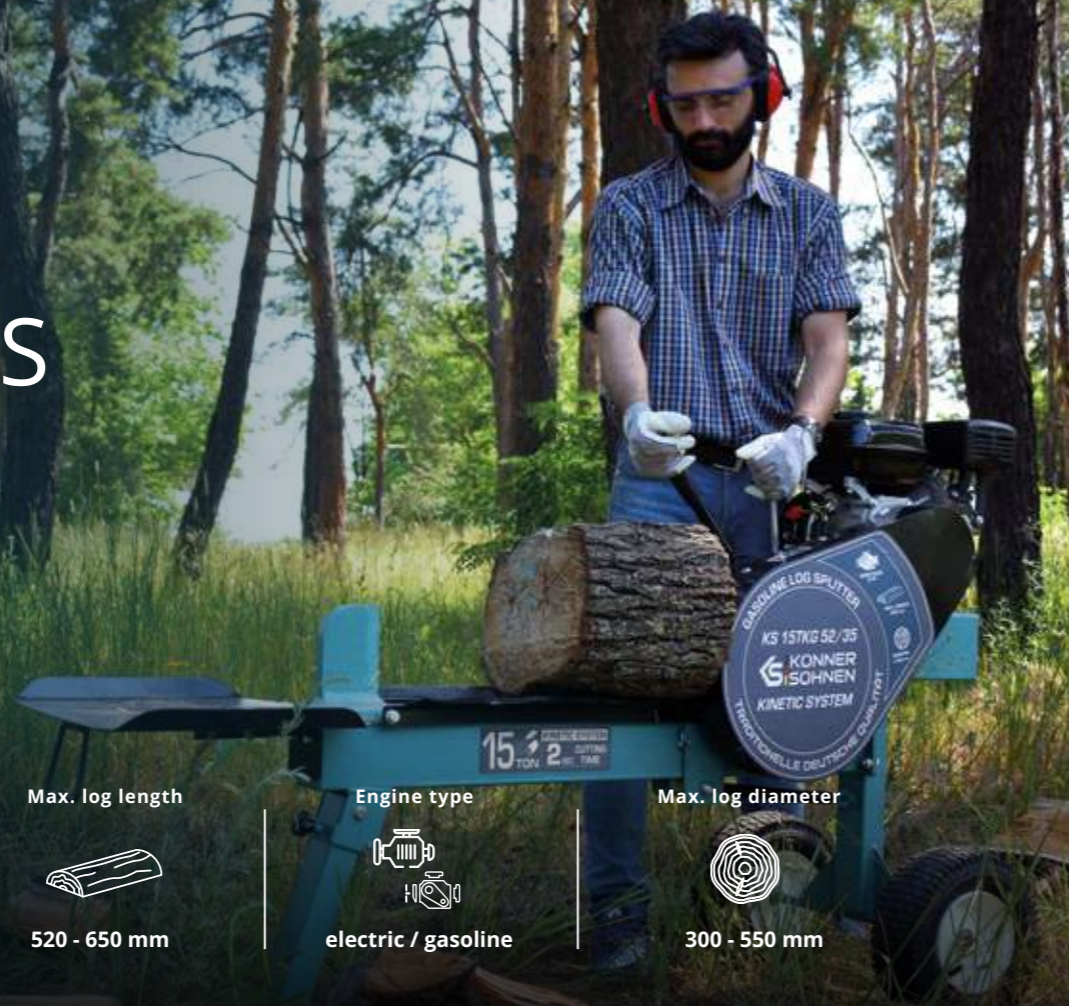

Splitting force



7-27 tons

Max. log length



520 - 650 mm

Engine type



electric / gasoline

Max. log diameter



300 - 550 mm

Könner & Söhnen® log splitters handle all types of wood — from dry logs to fresh timber — delivering maximum efficiency, user comfort, and long-term reliability.

Series includes electric and gasoline log splitters with a splitting force of 7-27 tons and wood chippers with engines from 6.5 to 15 HP. These machines are built for efficient processing of natural wood and wood waste, offering durability and reliability in every task.

The line features both hydraulic and kinetic splitters powered by high-performance engines and premium components. They handle logs up to 550 mm in diameter and 650 mm in length, whether dry or freshly cut — ideal for domestic or commercial use.

K&S wood chippers and log splitters make garden cleaning and firewood preparation fast and effortless while promoting resource-saving recycling.

Könner & Söhnen® log splitters make firewood preparation quick and effortless. The kinetic models achieve a splitting speed of up to 2 seconds — 5-7 times faster than hydraulic units — requiring only a simple lever action. The hydraulic models operate smoothly and safely, providing controlled, reliable splitting for any type of wood.



Protective metal housing



Wzmocniona rama luparki

Working position vertical/horizontal (for model KS 27THG 65/55)

Log pusher with maximum pressure of 27 tons

Tow bar for vehicle transport

Support wheel with brake (KS 27THG 65/55 model) or steel support leg

Wedge integrated into the splitter frame

Transport wheels



WATCH THE EQUIPMENT IN ACTION VIDEO



Powerful and reliable EURO 5 engine from Könner & Söhnen®

ELECTRIC LOG SPLITTERS

Könner & Söhnen® electric log splitters are compact, mobile, and powered by a reliable 2000 W motor. They are simple to operate, eco-friendly, and suitable even for indoor use — no fuel, no exhaust, no complex maintenance. The compact hydraulic design allows safe, smooth splitting of logs and provides enough time to load the next piece. Easy to transport and store, these splitters are ideal for everyday use.

KS 7THE 52/30

The hydraulic log splitter uses a motor-driven piston to deliver 7 tons of splitting force, ensuring smooth and controlled operation. Its eco-friendly motor and high-quality build handle dry or wet logs up to 300 x 520 mm efficiently.

Type of log splitter	hydraulic
Engine power	2000 W
Splitting force	7 tons
Engine type	electric
EAN code	4260405364138



CUTTING TIME 10 sec





KS 8TKE 52/35

The kinetic log splitter delivers **8 tons of force** and splits logs in **just 2 seconds**, allowing continuous, rapid operation. Its eco-friendly motor and durable components handle dry or wet logs up to **350 × 520 mm** with ease.

Type of log splitter	kinetic
Engine power	2000 W
Splitting force	8 tons
Engine type	electric
EAN code	4260405364145



VERTICAL ELECTRIC LOG SPLITTERS

Könner & Söhnen® vertical log splitters are designed for demanding conditions and continuous operation. Equipped with a **durable electric motor** and **reliable hydraulic drive**, they deliver consistent power and long service life. A **robust steel frame** ensures stability, while **transport wheels** make the unit easy to move and store - combining strength, efficiency, and convenience in one compact design.

KS 8THE V 55/40

This electric vertical log splitter delivers **8 tons** of force and handles logs up to **550 mm long and 400 mm in diameter**. With a **15-second** cycle time, it offers stable, controlled splitting in a compact vertical design.

Type of log splitter	hydraulic
Engine power	2300 W
Splitting force	8 tons
Engine type	electric
EAN code	4260405365692



KS 12THE V 65/40

This vertical electric log splitter delivers **12 tons** of splitting force, handling logs up to **650 mm long and 400 mm in diameter**. Its powerful, emission-free motor and durable steel construction ensure stable, efficient operation. A reinforced wedge, wide base, and low wedge position provide excellent stability, minimal vibration, and safer log handling with less lifting.

Type of log splitter	hydraulic
Engine power	2300 W
Splitting force	12 tons
Engine type	electric
EAN code	4260405365708



GASOLINE LOG SPLITTERS

Könner & Söhnen® gasoline log splitters deliver high power and stable performance in any weather. Resistant to moisture and temperature changes, they are equipped with **modern EURO 5-compliant engines** that meet all European quality and environmental standards.

KS 15TKG 52/35

The Könner & Söhnen® KS 15TKG 52/35 kinetic gasoline log splitter delivers **15 tons of force** and completes each cycle in **just 2 seconds**, saving time with every log.

It easily splits dry or wet wood up to **350 × 520 mm**, while the hardened steel wedge, welded into the frame, withstands heavy loads for long-term durability.

Type of log splitter	kinetic
Operating position	horizontal
Splitting force	15 tons
Engine type	gasoline
EAN code	4260405364152



KS 27THG 65/55

This hydraulic log splitter delivers an impressive **27 tons of force**, easily handling logs up to **650 mm long and 550 mm in diameter**.

Powered by a reliable gasoline engine, it works independently of the grid, combining horizontal and vertical splitting modes for greater convenience — no need to lift heavy logs.

Its reinforced steel frame, durable wedge, and stable base ensure safe, long-lasting operation even under intensive use.

Type of log splitter	hydraulic
Operating position	horizontal/vertical
Splitting force	27 tons
Engine type	gasoline
EAN code	4260405364169



Könner & Söhnen® engines are reliable, efficient, and fuel-saving, fully compliant with European and global quality standards, including the latest EURO 5 emission requirements.



ELECTRIC AND GASOLINE LOG SPLITTERS

TRADITIONELLE
DEUTSCHE
QUALITÄT



KS 7THE 52/30

KS 8TKE 52/35

KS 8THE V 55/40

Engine type	electric	electric	electric
Splitter type	hydraulic	kinetic	hydraulic
Voltage, V	230	230	230
Frequency, Hz	50	50	50
Motor power	2000 W	2000 W	2300 W
Splitting force, tons	7	8	8
Max. log length, mm	520	520	550
Max. log diameter, mm	300	350	400
Splitting speed, sec.	~ 10	~ 2	~ 15
Working position	horizontal	horizontal	vertical
Flywheel speed, rpm	-	400	-
Motor winding	copper	copper	copper
Wheels	6"	8"	8"
Dimensions (L×W×H), mm	980x270x520	1270x340x780	570x380x1160
Net weight, kg	47	110	114
Gross weight, kg	49	130	126
Protection class	IP54M	IP54M	IP54M

QR Code



EAN code

4 260405 364138

4 260405 364145

4 260405 365692

ACCESSORIES FOR THIS PRODUCT (sold separately)
page: 100, 101



ADDITIONAL ACCESSORIES

	STAND FOR SPLITTER	TABLE FOR SPLITTER	LOG LIFTING LEVER
KS 7THE 52/30	KS Bracket	-	KS Lever
KS 8TKE 52/35	-	KS 8-15Table	KS Lever
KS 15TKG 52/35	-	KS 8-15Table	KS Lever
KS 27THG 65/55	-	KS 27Table	KS Lever
KS 8THE V 55/40	-	-	KS Lever
KS 12THE V 65/40	-	-	KS Lever
EAN code	4260405364541	7139446325424 7139446292656	7139446194352



KS 12THE V 65/40

KS 15TKG 52/35

KS 27THG 65/55

Engine type	electric	gasoline	gasoline
Splitter type	hydraulic	kinetic	hydraulic
Voltage, V	230	-	-
Frequency, Hz	50	-	-
Motor power	2300 W	6,5 hp	6,5 hp
Splitting force, tons	12	15	27
Max. log length, mm	650	520	650
Max. log diameter, mm	400	350	550
Splitting speed, sec.	~ 25	~ 2	~ 15
Working position	vertical	horizontal	vertical / horizontal
Flywheel speed, rpm	400	450	450
Motor winding	copper	-	-
Wheels	8"	12"	16"*4.8-8, support wheel with brake
Dimensions (L×W×H), mm	710x450x1170	1400x380x610	2250x505x570
Net weight, kg	110	97	260
Gross weight, kg	123	110	295
Protection class	IP54M	IP54M	IP54M

QR Code



EAN code

4 260405 365708

4 260405 364152

4 260405 364169

ACCESSORIES FOR THIS PRODUCT (sold separately)
page: 100, 101





WOOD CHIPPERS

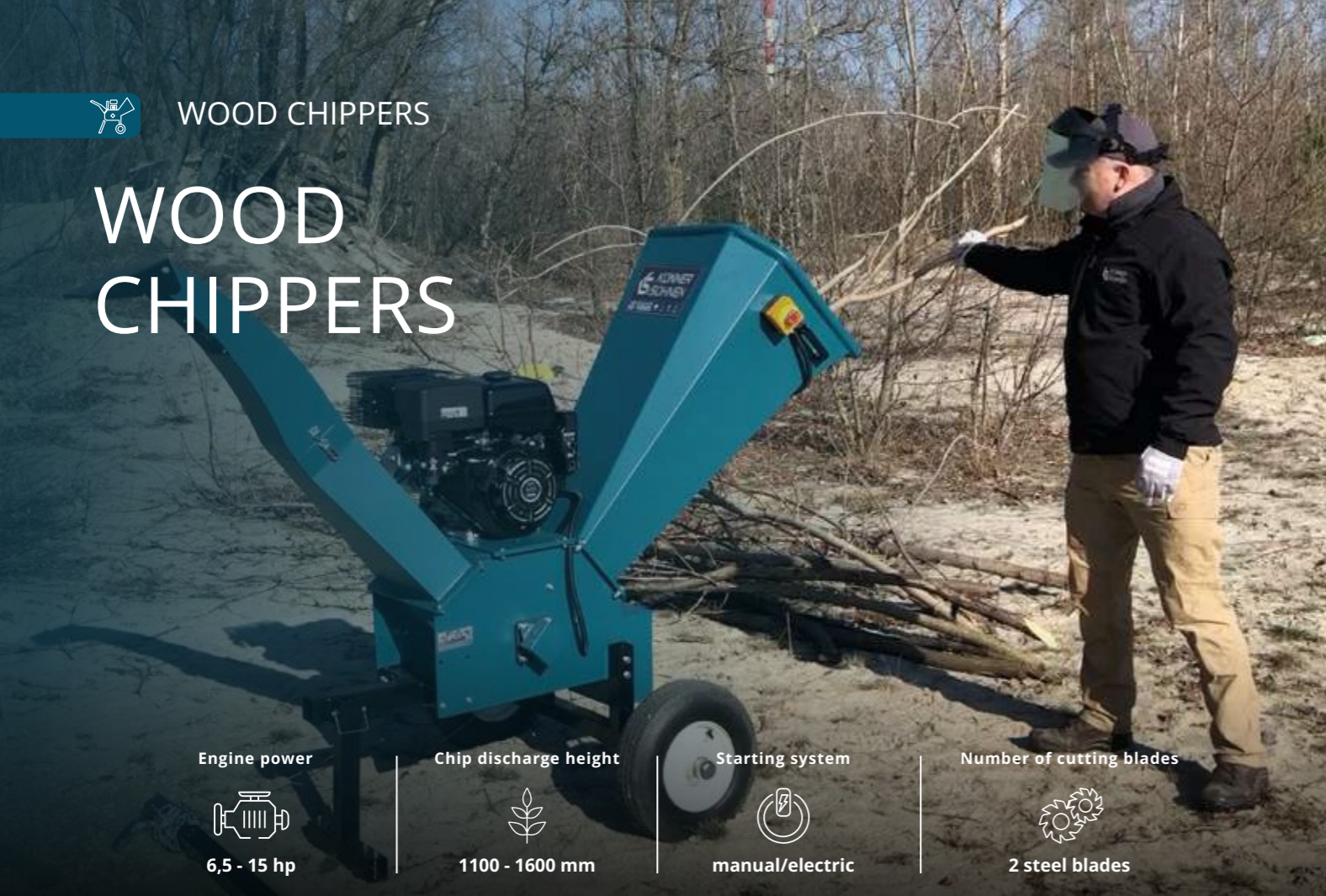

Engine power



6,5 - 15 hp

Chip discharge height



1100 - 1600 mm

Starting system



manual/electric

Number of cutting blades



2 steel blades

Könner & Söhnen® gasoline wood chippers are highly mobile units that operate independently of external power sources. They're ideal for private households, orchards, gardens, and municipal work — from cleaning parks and playgrounds to maintaining large outdoor areas.

Instead of burning garden waste — an environmentally harmful and legally restricted method — **K&S wood chippers** provide an efficient recycling solution. They shred **branches, vines, and other plant residues** into **wood chips (3–20 mm)**, suitable for use as **fuel** (in solid-fuel boilers, fireplaces, and stoves) or as **mulch** for plants.

Equipped with **fast, hardened steel blades**, the chippers handle **dry and fresh wood up to 120 mm in diameter**, ensuring stable, reliable performance in any conditions.

MAXIMUM SAFETY AND USER COMFORT GUARANTEED:

- ✓ **Large loading hopper** for easy feeding and quick shredding of branches
- ✓ **Silicone inlet cover** prevents debris from ejecting toward the operator
- ✓ **Protective kit included:** polycarbonate safety screen, gloves, and ear protectors



RECYCLING WASTE SAVES
NATURAL RESOURCES

Discharge chute with adjustable ejection height for finished material

Large hopper for easy feeding of shredded material

Reliable K&S engine complies with all European quality standards, including EURO 5

Emergency stop button (for model KS 700WS)

Powerful cutting mechanism for shredding branches up to Ø120 mm



Solid and stable frame construction

Low center of gravity ensures stability and maneuverability

Tow bar for attaching the machine to a vehicle

Pneumatic wheels for easy transportation



WATCH THE MACHINE
IN ACTION

- ✓ **TWO HARDENED CARBON-STEEL BLADES**
Efficiently shred all types of wood — from dry branches to fresh plant waste up to Ø120 mm.
- ✓ **POWERFUL BRAND ENGINE**
Modern gasoline engines meet strict European standards, including **EURO 5**.
- ✓ **EASY TRANSPORTATION & STABILITY**
A **low center of gravity** keeps the machine steady and easy to maneuver, even during heavy-duty use.
- ✓ **MOBILITY**
Pneumatic wheels ensure smooth movement over uneven surfaces such as gravel or soil.
- ✓ **HIGH-PERFORMANCE MODEL**
The **KS 700WS** chipper with a **420 cm³ / 15 HP engine** is built for intensive workloads — robust, durable, and ready for professional applications.



KS 400WS

KS 400WS garden shredder is a versatile choice for homeowners and garden owners. It features **two feed hoppers**: a large top hopper for leaves, grass, straw, and thin branches up to **10 mm**, and a side hopper for dry or fresh wood up to **45 mm** (combined capacity up to 76 mm).



Engine power	6.5 hp
Start	manual
Maximum input diameter (hopper)	76 mm
Net weight	70 kg
EAN code	4260405361618

KS 500WS

KS 500WS gasoline wood chipper-shredder is a powerful, mobile, and reliable machine for private, agricultural, and garden use. Its large feed hopper and **two hardened steel blades** efficiently shred branches **up to 76 mm** in diameter, while the adjustable discharge chute controls chip ejection height. Equipped with large pneumatic wheels, it's easy to move even across uneven ground.



Engine power	6.5 hp
Start	manual
Maximum input diameter (hopper)	76 mm
Net weight	95 kg
EAN code	4260405361618

KS 700WS

KS 700WS gasoline wood chipper-shredder is the most powerful model in the range, built for heavy-duty garden and agricultural work. Its **15 hp** engine handles branches **up to 120 mm** in diameter, **while large 16"** pneumatic wheels and a low center of gravity ensure stability and easy transport. Features include manual or electric start and an adjustable **1600 mm** chip ejection height.



Engine power	15 hp
Start	manual/electric
Maximum input diameter (hopper)	120 mm
Net weight	210 kg
EAN code	4260405361687

Included in the set:
protective polycarbonate
screen, gloves, and earmuffs.



KS 400WS



KS 500WS



KS 700WS

Engine power, hp	6,5	6,5	15
Start	manual	manual	manual/electric
Number of cutting blades, pcs.	2	2	2
Max. input diameter (hopper), mm	76	76	120
Single element diameter (hopper), mm	10	30	50
Max. input diameter (side feed), mm	76	-	-
Single element diameter (side feed), mm	45	-	-
Ejection height, mm	-	1100	1600
Output chip size, mm	3-4	10-15	10-20
Blade speed, rpm	2400	3000	3000
Engine type	gasoline, 4-stroke	gasoline, 4-stroke	gasoline, 4-stroke
Engine displacement, cm ³	196	196	420
Engine model	KS 230	KS 230	KS 430
Engine speed, rpm	3600	3600	3600
Fuel tank capacity, l	3,6	3,6	6,5
Oil tank capacity, l	0,6	0,6	1,1
Wheels	10"	12"	16"
Dimensions net (LxWxH), mm	920x730x1275	1500x740x1300	2550x1100x1600
Dimensions gross (LxWxH), mm	750x480x1150	880x480x760	1140x660x1120
Net weight, kg	70	95	210
Gross weight, kg	80	110	230
Protection class	IP54M	IP54M	IP54M
QR code			
EAN code	4 260405 365272	4 260405 361618	4 260405 361687

ACCESSORIES FOR THIS PRODUCT (sold separately)
page: 100, 101



Köner & Söhnen® engines are **reliable, efficient, and fuel-saving**, fully compliant with European and global quality standards, including the latest EURO 5 emission requirements.

SOIL



TILLERS



**MULTISEASON
MULTIFUNCTIONAL
4-IN-1 MACHINE**



TILLERS

ELECTRIC TILLERS



Engine power



1000-2000 W

Voltage



230 V

Working width



≤ 36-55 cm

Low noise level



lpa (7m) - 68 db

TRADITIONELLE
DEUTSCHE
QUALITÄT



Power button

Ergonomic control panel with adjustable handles

Foldable frame for compact storage

Eco-friendly and reliable
Könner & Söhnen® engine

High-strength steel blades

Ventilation openings for motor cooling

Transport wheel



The **Könner & Söhnen® tiller range** covers every gardening need — from loosening light soil to cultivating dense clay, planting, weeding, and harvesting.

Compact **electric tillers** are perfect for narrow areas and greenhouses, offering easy maneuverability in limited spaces, while **powerful gasoline models** handle demanding work on medium and large plots.

The **ECO electric series** is designed for small gardens and decorative landscapes — **light, quiet, and eco-friendly**, requiring minimal maintenance and no special skills to operate.

- ✓ Protection against accidental start-up
- ✓ Eco-friendly and almost silent K&S electric motor
- ✓ High maneuverability
- ✓ Ergonomic control panel with adjustable handles
- ✓ Chain transmission transfers up to 95% of engine torque
- ✓ Wheels for easy transport (in model KS 1500T E)
- ✓ Optimal power-to-weight ratio



KS 1000T E



KS 1500T E

Environmentally friendly and reliable
Könner & Söhnen® engine

	KS ECO 1000	KS ECO 1500
Engine model	KS ECO 1000	KS ECO 1500
Engine power, W	1000	1500
Voltage, V	230	230
Frequency, Hz	50	50
Engine type	electric	electric
Working width, cm	≤ 36	≤ 45
Working depth, cm	≤ 22	≤ 22
Noise level Lpa (7m)/Lwa, dB	68/93	68/93
Dimensions (LxWxH), mm	380x275x530	480x320x545
Net weight, kg	10	14,5
QR code		
EAN code	4 260405 363728	4 260405 361809

ACCESSORIES FOR THIS PRODUCT (sold separately)
page: 101





GASOLINE TILLERS

Engine power



5 - 9hp

Drive type



belt, chain, direct drive

Working width



≤ 50 - 134 cm

Number of cutting blades



with the possibility of
installing attachments

WITH BELT DRIVE

Könnner & Söhnen® gasoline tillers with belt drive (5-7 HP) are designed for **cultivating all soil types**, from light to heavy clay. Compact yet powerful, they handle a wide range of agricultural tasks — from **soil preparation and planting** to **harvesting and maintenance**.

Their **modern design** combines functionality with a compact, stylish form.

Models **KS 4HP-70** and **KS 7HP-850A** feature **transport wheels** for easy maneuvering on small plots, while **KS 7HP-850A**, **KS 7HP-950A**, and **KS 7HP-950S** support **accessory attachments** such as **ridgers**, **ploughs**, **potato diggers**, and **metal wheels** — making them versatile tools for any season.



POWERFUL ENGINES

Könnner & Söhnen® engines are powerful, reliable, and fully compliant with **European quality standards**, including **EURO 5**. Each engine carries a unique serial number for precise production control and dependable service support.



ERGONOMIC CONTROL PANEL

The **ergonomic control panel** ensures easy handling and precise maneuvering. All models feature **vertical and horizontal handle adjustment** for comfort and compact storage, while the **KS 7HP-950S** includes a **built-in tool case** for added convenience.



Ergonomic control panel, handle rotation vertically 180° and horizontally 360°

Powerful and reliable EURO 5 engine from Könnner & Söhnen®



Forged blades with side protection discs (can be used on any type of soil, including hard and uncultivated soil)

Reinforced drawbar with option to attach accessories

Transport wheel or support leg

Low-profile tubeless wheels



VIEW IN 3D



WATCH THE MACHINE IN ACTION



FORGED BLADES

Forged, saber-shaped blades easily handle any type of soil, including virgin ground. Equipped with protective discs (except model **KS 7HP-850A**), they offer a **working width of 50-108 cm** and a **depth of up to 31 cm** — ideal for efficient cultivation in any condition.



QUALITY IN DETAILS

Every **joint and assembly unit** is engineered for durability, safety, and operator comfort. **Reinforced components, precision joints, and rubber seals** minimize vibration and noise, ensuring smooth, stable tiller operation.



GASOLINE TILLERS

TRADITIONELLE
DEUTSCHE
QUALITÄT



KS 4HP-70

KS 4HP-70 gasoline cultivator is a compact and efficient machine for small to medium plots. Its forged saber-shaped cutters (**up to 70 cm width**) handle all soil types with ease, while protective side discs keep plants safe.

Engine power	5 hp
Drive type	belt, worm gear
EAN code	4260405363926



KS 7HP-850A

KS 7HP-850A gasoline cultivator is a powerful and easy-to-use tool for small and medium plots. Its **80 cm tilling width** and chain transmission delivering up to 95% torque efficiency ensure excellent performance on any soil. A vertically adjustable ergonomic control panel provides comfort and compact storage, while the balanced power-to-weight design makes operation smooth and effortless.

Engine power	7 hp
Drive type	belt, chain
EAN code	4260405363506



KS 7HP-950A

KS 7HP-950A gasoline cultivator is a versatile and reliable machine for soil preparation, planting, hilling, and harvesting. With a **tilling width of up to 108 cm**, it efficiently handles soils of varying hardness. Its compact design and **180° adjustable ergonomic control panel** ensure comfort, maneuverability, and convenient storage.

Engine power	7 hp
Drive type	belt, chain
EAN code	4260405363513



KS 7HP-950S

KS 7HP-950S gasoline cultivator is a durable and multifunctional tool for soil preparation, planting, hilling, and harvesting. It offers a **108 cm tilling width** and features a **360° vertically and 180° horizontally adjustable control panel** for easy handling and compact storage. A **built-in toolbox** adds extra convenience during work.

Engine power	7 hp
Drive type	belt, chain
EAN code	4260405363520



EQUIPMENT

Könner & Söhnen® tillers with belt drive (**KS 7HP-850A, KS 7HP-950A, KS 7HP-950S**) and models with **direct drive and gearbox** can be equipped with a variety of attachments.

A **wide range of accessories** is available to handle all soil types and adapt the tiller to specific user needs.

Potato plough

KS PP4

Weight	4,5 kg
EAN code	4260405361748



Sided plough

KS SP2

Weight	4,2 kg
EAN code	4260405361816

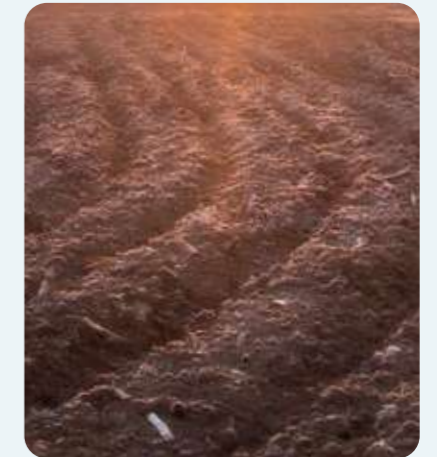

Adjustable ditcher

KS AD3

Weight	4 kg
EAN code	4260405361823



Simple ditcher

KS SD1

Weight	2 kg
EAN code	4260405361755



Forged Knife

KS BL10

EAN code	4260405362240
----------	---------------



Pneumatic wheels

KS RW40

Diameter	4.00 - 8"
Weight	4 kg
EAN code	4260405361878



Metal grouser

KS MG40

Diameter	46,5 cm
Width	10 cm
Weight	3,3 kg
EAN code	4260405363599



Axle for wheel mounting

KS AT23

Hex diameter	23 cm
Hub length	20 cm
EAN code	4260405363773



(compatible with models KS 7HP-850A, KS 7HP-950A, KS 7HP-950S, KS 7HP-1050G, KS 9HP-1350G-3)



HEAVY-DUTY TILLERS WITH GEARBOX

Könner & Söhnen® continues to enhance its heavy-duty tiller series with direct drive and gearbox, offering a reliable alternative to diesel tillers or even mini-tractors. The **KS 9HP-1350G-3** model features an **extended gearbox with three forward speeds and a reverse gear**, as well as an **active PTO** for connecting attachments such as **motor or sprayer pumps**. A **trailer** can also be attached for transporting loads, while the **working width reaches up to 134 cm** — ideal for large-scale tasks. The **gear-driven transmission** ensures durability and consistent performance under heavy loads. All models are powered by **efficient K&S engines** that meet **European quality standards**, including **EURO 5**.

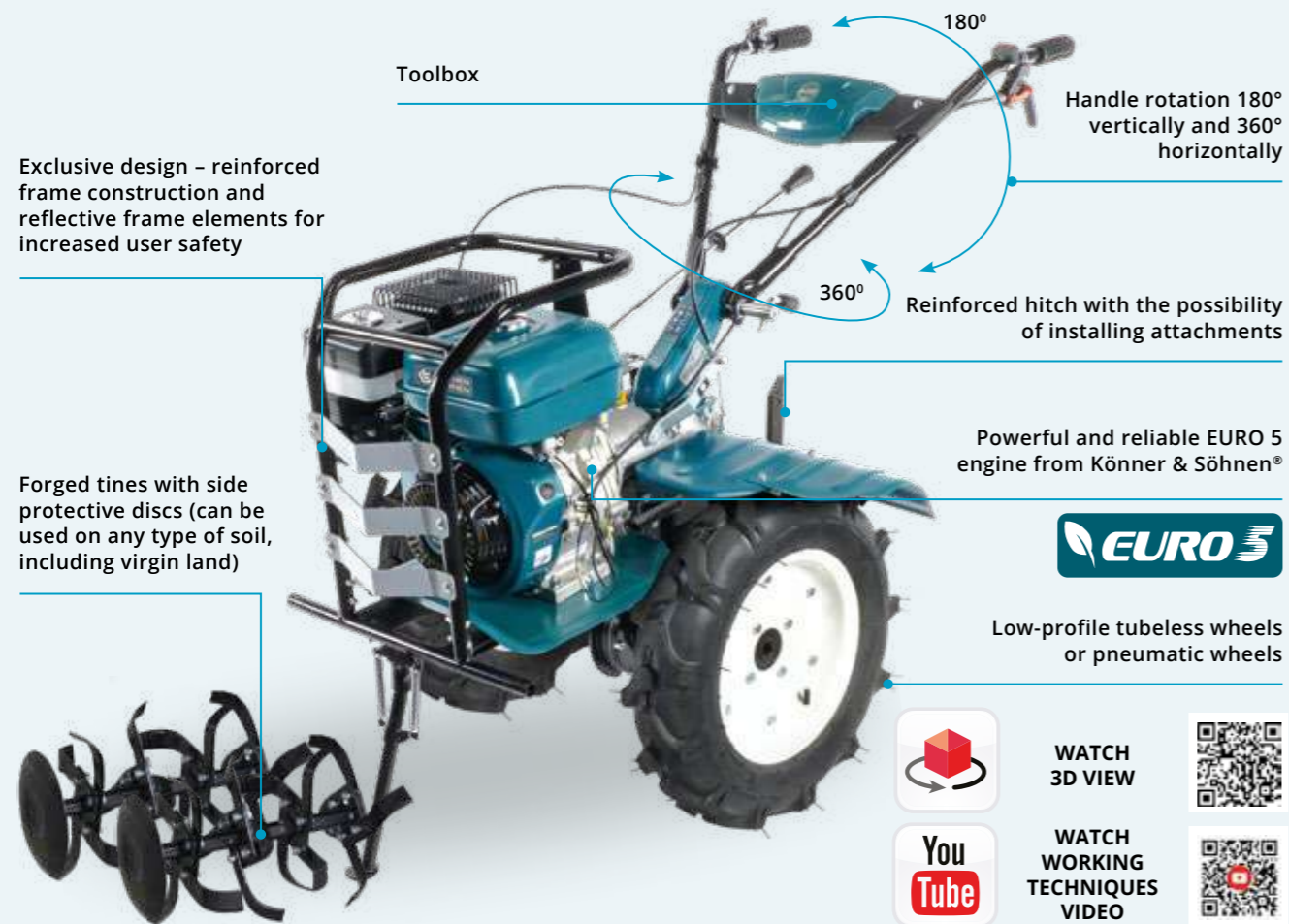

TUBELESS OR PNEUMATIC WHEELS

Könner & Söhnen® tillers are equipped with durable wheels for stable operation on any terrain. The **KS 7HP-1050G** features **low-profile tubeless wheels** that require no pumping, while the **KS 9HP-1350G-3** comes with **pneumatic wheels** sized **4.00-8" or 5.00-12"**, providing excellent traction and maneuverability.

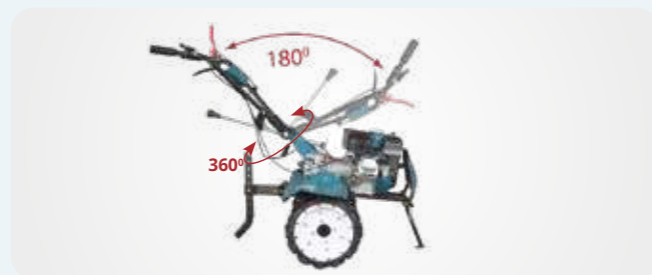

ERGONOMIC CONTROL PANEL

The **ergonomic control panel** provides effortless handling and precision. Handles adjust **vertically up to 180°** and **horizontally up to 360°**, ensuring comfort and compact storage. A **built-in toolbox** keeps essential accessories close at hand.

KS 7HP-1050G

KS 7HP-1050G gasoline cultivator is a powerful, reliable machine designed for all soil types — from loose to dense clay. Its **direct-drive reinforced gearbox with bevel gear** ensures long-lasting performance under heavy loads. An **ergonomic control panel** provides easy handling and compact storage, while the **built-in toolbox** keeps essential tools within reach.

EAN code 4260405363537



KS 9HP-1350G-3

KS 9HP-1350G-3 gasoline cultivator is a high-performance model built for medium to large plots and all soil types — from light to dense clay. Its **9 hp engine, direct-drive reinforced gearbox, and bevel gear system** deliver reliable power and durability under heavy loads, while **the 134 cm tilling width** ensures efficient soil processing.

EAN code 4260405363544



EQUIPMENT

Könner & Söhnen® tillers with **belt drive** (KS 7HP-850A, KS 7HP-950A, KS 7HP-950S) and models with **direct drive and gearbox** support a wide range of attachments. This equipment is designed for **all soil types**, allowing users to adapt their tillers to specific agricultural tasks and needs.



	Metal Wheels KS MW40	Metal Wheels KS MW45	Pneumatic Wheels KS RW50
Diameter	39,5 cm	42 cm	5.00-12"
Width	18,5 cm	19,5 cm	9,6 kg
Weight	8 kg	8 kg	
EAN code	4 260405 365272	4 260405 361618	4 260405 361687



Triple subsoil cultivator allows working the soil in both directions.

	Double Plough KS DP1	Adjustable Ridger KS AP1	Cultivator KS WP1
Net weight	39,5 cm	42 cm	5.00-12"
Gross weight	18,5 cm	19,5 cm	9,6 kg
EAN code	4 260405 365272	4 260405 361618	4 260405 361687



GASOLINE TILLERS

TRADITIONELLE
DEUTSCHE
QUALITÄT



KS 4HP-70 **KS 7HP-850A** **KS 7HP-950A** **KS 7HP-950S**

Engine model	KS 160	KS 240	KS 240	KS 240
Engine power, hp	5	7	7	7
Engine displacement, cm ³	173	212	212	212
Engine type	gasoline	gasoline	gasoline	gasoline
Working width, cm	50-70	≤ 80	≤ 108	≤ 108
Working depth, cm	≤ 27	≤ 31	≤ 31	≤ 31
Fuel tank capacity, l	1,5	3,6	3,6	3,6
Oil tank capacity, l	0,6	0,6	0,6	0,6
Transmission oil capacity, l	0,1	-	1,2	1,2
Drive type	belt, worm gear	belt, chain	belt, chain	belt, chain
Number of speeds	1	+1 0 -1	+2 +1 0 -1	+2 +1 0 -1
Reverse gear	-	+	+	+
Handle adjustment	vertical	vertical	vertical	vertical/ horizontal
Transport wheels	transport wheel	transport wheel	transport wheel, possibility of additional pneumatic wheels	low-profile tubeless wheels
Noise level Lpa (7m)/Lwa, dB	68/93	73/98	73/98	73/98
Gross dimensions (LxWxH), mm	680x380x650	690x380x770	845x460x660	780x460x780
Net weight, kg	36	52	62	80
Gross weight, kg	40	56	71	89

QR Code



EAN code

4 260405 363926

4 260405 363506

4 260405 363513

4 260405 363520

ACCESSORIES FOR THIS PRODUCT (sold separately)
page: 100, 101



Könnér & Söhnen® engines are reliable, efficient, and fuel-saving, fully compliant with European and global quality standards, including the latest EURO 5 emission requirements.



KS 7HP-1050G



KS 9HP-1350G-3 (400) / (500)

Engine model	KS 240	KS 290
Engine power, hp	7	9
Engine displacement, cm ³	212	270
Engine type	gasoline	gasoline
Working width, cm	≤ 108	≤ 134
Working depth, cm	≤ 35	≤ 35
Fuel tank capacity, l	3,6	6,0
Oil tank capacity, l	0,6	1,1
Transmission oil capacity, l	1,2	1,5
Drive type	direct drive	direct drive
Number of speeds	+2 +1 0 -1	+3 +2 +1 0 -1
Reverse gear	+	+
Handle adjustment	vertical/horizontal	vertical/horizontal
Transport wheels	pneumatic wheels 4.00-8"	pneumatic wheels 4.00-8" or 5.00-12"
Noise level Lpa (7m)/Lwa, dB	73/98	73/98
Gross dimensions (LxWxH), mm	910x460x690	910x570x750
Net weight, kg	83	94
Gross weight, kg	92	110

QR Code



EAN code

4 260405 363537

4 260405 363544

ACCESSORIES FOR THIS PRODUCT (sold separately)
page: 100, 101



Könnér & Söhnen® engines are reliable, efficient, and fuel-saving, fully compliant with European and global quality standards, including the latest EURO 5 emission requirements.



MULTISEASON MULTIFUNCTIONAL MACHINE 4 IN 1

MULTISEASON MULTIFUNCTIONAL MACHINE 4 IN 1



The **Könner & Söhnen® multifunctional machine** is a **self-propelled, all-season unit** designed to perform a wide range of tasks year-round — at home, on commercial sites, or in public areas. Its **active attachments** make it easy to handle **snow, dust, dirt, leaves, and debris** without extra effort from the operator.

Perfect for **private households, hotels, farms, gardens, and recreational areas**, this machine replaces multiple tools while remaining compact and efficient.

5 MAIN ADVANTAGES:

- ✓ **COST SAVINGS** — no need to buy separate machines
- ✓ **OPERATING COST SAVINGS** — maintain and refuel only one unit
- ✓ **TIME SAVINGS** — quick attachment changes without tools
- ✓ **SPACE SAVINGS IN STORAGE** — compact design for year-round use
- ✓ **EFFORT SAVINGS** — one engine, interchangeable attachments



TRADITIONELLE
DEUTSCHE
QUALITÄT



4 IN 1
AN ESSENTIAL HELPER IN
EVERY SEASON

AGILITY AND VERSATILITY

Compact size and small turning radius ensure versatility and increased maneuverability of this model with the full range of attachments, even in tight spaces.

INCREASED NUMBER OF GEARS

The number of gears (5 forward and 2 reverse) allows you to choose the optimal speed for any task.

QUALITY IN DETAILS

All connections and mounts are well thought out and designed with a safety margin for long-lasting and reliable machine operation.

K&S BRAND ENGINE

A reliable, powerful engine prepared for heavier loads, with 6.5 hp, meets the latest EURO 5 environmental standard.



MAXIMUM PERFORMANCE

Direct-drive gearbox provides more power and efficiency with every attachment.

MULTISEASON RUBBER WITH HIGH LEVEL OF PROTECTION

Wide pneumatic wheels 13x4.1-6 of high quality ensure easy movement on both soil and snow.



WATCH
WORKING
TECHNIQUES
VIDEO



MULTIFUNCTIONAL MACHINE
KS 7HP-MFM 60

MULTIFUNCTIONAL MACHINE
KS 7HP-MFM 80

MULTIFUNCTIONAL MACHINE
KS 7HP-MFM 80E

	direct drive	direct drive	direct drive
Drive			
Engine model	KS 220	KS 220	KS 220
Engine type	gasoline	gasoline	gasoline
Engine power	5,5 hp	5,5 hp	5,5 hp
Start	manual	manual	manual/electric
Fuel tank capacity	2,5 l	2,5 l	2,5 l
Fuel consumption*	1,2 - 1,8 l/h	1,2 - 1,8 l/h	1,2 - 1,8 l/h
Net weight	72 kg	74 kg	77 kg
Gross weight	80 kg	88 kg	88 kg
EAN code	4260405363933	4260405366583	4260405363940

*Fuel consumption depends on many factors, such as load, fuel quality, season, altitude above sea level, technical condition.

ACCESSORIES FOR THIS PRODUCT (sold separately)
page: 100, 101





The Könnert & Söhnen® multifunctional machine with a sweeper is a universal device that can be used all year round. The sweeper has many functions – it quickly and effectively handles dust, dirt, fallen leaves, and snow. It is an indispensable helper for keeping yards, driveways, and garages clean, as well as paths in parks, squares, and other areas.

- ✓ High-quality bristles
- ✓ Adjustable working angle

SWEEPER

KS 7HP-MFM 60 KS 7HP-MFM 80E



Brush diameter	345 mm
Working width	60/80 cm
Angle adjustment	± 15°
Brush rotation speed	255 rpm
Gross dimensions (60/80 cm)	620/820x570x420 mm
Net weight (60/80 cm)	32/35 kg
Gross weight (60/80 cm)	38/43 kg



Dust container for Könnert & Söhnen® sweeper – effectively handles dust and dirt, prevents dust from spreading outside during high-speed operation.

- ✓ Large container for dust and debris
- ✓ High maneuverability thanks to 360° rotating wheels

DUST CONTAINER

KS MFM-DB 60 KS MFM-DB 80



Working width	60/80 cm
Gross dimensions (60/80 cm)	630/830x390x335 mm
Net weight (60/80 cm)	6,6/8,5 kg
EAN code	4260405363957 4260405363964



ADDITIONAL ACCESSORIES

A set of spare brushes for a wide range of cleaning tasks throughout the year. Suitable for KS 7HP-MFM 80E and KS 7HP-MFM 60 sweepers. Quickly and effectively handles dust, dirt, fallen leaves, and snow.

SPARE BRUSH SET

KS MFM BK 80/26



Gross dimensions (60/80 cm)	360x360x340 mm
Net weight (60/80 cm)	4,96 kg
EAN code	4260405364039



The efficient auger snow blower for the Könnert & Söhnen® multifunctional machine quickly handles large snowdrifts and packed snow.

- ✓ Sharp serrated edge easily copes even with compacted snow
- ✓ Reinforced auger with stiffeners
- ✓ Includes snow shovel and auger rotor

SNOW BLOWER

KS MFM-SB 60



Chute rotation	270°
Snow discharge distance	0-10 m
Gross dimensions	600x470x470 mm
Net weight	21 kg
EAN code	4260405363971



The snow plough for the Könnert & Söhnen® multifunctional machine is designed not only for snow removal, but also for clearing sand and other loose materials, as well as for cutting and preparing soil.

- ✓ Equipped with a handle for more convenient operation

SNOW SHOVEL

KS MFM-SS 60 KS MFM-SS 80



Working width	60/80 cm
Gross dimensions (60/80 cm)	620/820x465x110 mm
Net weight (60/80 cm)	6,6/7,7 kg
EAN code	4260405363988 4260405363995



ADDITIONAL ACCESSORIES

ANTI-SLIP CHAIN

KS MFM SC 13/4.1



Net weight (60/80 cm)	2,18 kg
EAN code	4260405364046

PNEUMATIC WHEELS

KS MFM RW 13/4.1



Wheel size	13*4.1-6
EAN code	4260405364053

LED SPOTLIGHT

KS MFM LAMP



Net weight (60/80 cm)	0,16 kg
EAN code	4260405364022



WATER



PRESSURE WASHERS

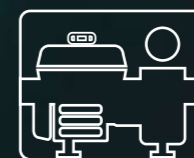

WATER PUMPS



PRESSURE WASHERS



Motor power



Pressure



Water consumption

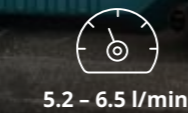

Köner & Söhnen® pressure washers make it easy to remove dirt from **vehicles, terraces, facades, and garden tools**. Depending on the model, they feature **an automatic start/stop system, hose reel, telescopic handle**, and both **vertical and horizontal operation modes**. Adjustable pressure settings ensure perfect results for every task.

✔ HIGH PERFORMANCE & DURABILITY

Powerful **electric motors**, including modern **brushless units**, deliver high efficiency and wear resistance. **Aluminum pumps with stainless steel pistons** maintain stable pressure and long-term reliability.

✔ USER COMFORT

Quick connectors, hose reel, and compact design make transport and storage effortless. **Ergonomic spray guns and adjustable lances** provide precise water control for any surface.

✔ VERSATILE APPLICATION

Ideal for everything from **bicycles and garden furniture to paving stones, off-road vehicles, and agricultural machinery**

✔ COMPLETE EQUIPMENT

Each washer comes ready to use with practical accessories — **foam lance, turbo nozzle, adjustable spray lance**, and, in selected models, a **hose reel**. Everything you need for clean, efficient work straight out of the box.



KS PW130H

Voltage	220-240 V
Frequency	50/60 Hz
Power	1600 W
Maximum pressure	130 bar
Working pressure	90 bar
Water flow rate	5,2 l/min
Dimensions (L×W×H)	386x250x280 mm
Weight	5,4 kg
EAN code	4260405368648



A **compact and lightweight 1600 W pressure washer** designed for home use. The **horizontal body** ensures excellent stability and prevents tipping, while the **aluminum pump with stainless steel pistons** guarantees long-lasting durability. A **7 m hose and 550 ml foam sprayer** make it perfect for cleaning **cars, bicycles, and garden furniture** with ease.

- ✔ Stable horizontal design
- ✔ High efficiency with low power consumption
- ✔ Lightweight and easy to carry
- ✔ Durable aluminum pump with steel pistons

KS PW145V

Voltage	220-240 V
Frequency	50/60 Hz
Power	1800 W
Maximum pressure	145 bar
Working pressure	100 bar
Water flow rate	5,5 l/min
Dimensions (L×W×H)	365x305x555 mm
Weight	9,2 kg
EAN code	4260405368655



The Köner & Söhnen® **1800 W pressure washer** delivers up to **145 bar** of pressure and a **5.5 l/min flow rate** — ideal for cleaning **terraces, facades, and cars**. A **telescopic handle and hose reel** make it easy to move and store, while **quick connectors** simplify setup. The set includes a **550 ml foam sprayer, turbo nozzle, and adjustable spray nozzle** for versatile use.

- ✔ Telescopic handle and hose reel
- ✔ Quick nozzle connectors
- ✔ Compact accessory storage
- ✔ Efficient cleaning of medium-sized surfaces



KS PW160HV

Voltage	220-240 V
Frequency	50 Hz
Power	1800-2200 W
Maximum pressure	160 bar
Working pressure	70~110 bar
Water flow rate	5,6 l/min
Dimensions (L×W×H)	520×410×385 mm
Weight	12,9 kg
EAN code	4260405368662



KS PW160HV pressure washer for every cleaning task — from delicate surfaces to heavy dirt removal. With **1800–2200 W power, 160 bar pressure, and a 5.6 l/min flow rate**, it delivers strong, adjustable performance. Operates **vertically or horizontally**, featuring an **enlarged 1 L foam sprayer, 8 m hose, and adjustable pressure control** for maximum versatility.

- ✓ Adjustable washing power
- ✓ Vertical and horizontal operation
- ✓ Enlarged 1 L foam sprayer
- ✓ High pressure for demanding tasks

KS PW160V-BL

Voltage	220-240 V
Frequency	50/60 Hz
Motor type	brushless
Power	2000 W
Maximum pressure	160 bar
Working pressure	110 bar
Water flow rate	6,5 l/min
Weight	16,0 kg
EAN code	4260405368679



The Könnert & Söhne® 2000 W pressure washer features a **brushless induction motor** for high performance and long service life. An **8 m steel-braided hose and metal lance** ensure durability under intensive use, while the **telescopic handle, hose reel, and ergonomic spray gun** provide maximum comfort.

- ✓ Brushless induction motor
- ✓ Reinforced steel-braided hose
- ✓ Metal lance and durable components
- ✓ High performance for extended use



RELIABLE BRUSHLESS MOTOR

The use of a brushless motor ensures high performance and long service life. This motor type features fewer moving parts requiring maintenance and provides low noise levels during operation.



	KS PW130H	KS PW145V	KS PW160HV	KS PW160V-BL
Voltage	220-240V	220-240V	220-240V	220-240V
Frequency	50 Hz	50 Hz	50 Hz	50 Hz
Power	1600 W	1800 W	adjustable motor power 1800–2200 W	2000 W
Max. Pressure	130 bar	145 bar	160 bar	160 bar
Working Pressure	90 bar	100 bar	70~110 bar	110 bar
Water Flow Rate	5,2 l/min	5,5 l/min	5,6 l/min	6,5 l/min
Hose Length	7 m	7 m	8 m	8 m
Dimensions (L×W×H)	386×250×280 mm	365×305×555 mm	520×410×385 mm	380×380×710 mm
Weight	6,1 kg	11 kg	12,9 kg	16,0 kg
EAN code	4260405368648	4260405368655	4260405368662	4260405368679

ACCESSORIES FOR THIS PRODUCT (sold separately)
page: 101



EQUIPMENT

Foam Nozzle KS FJC1L



Volume	1000 ml
Max Temperature	60 °C
EAN code	4260405368693

Foam Nozzle KS FJC1L-2



Volume	1000 ml
Max Temperature	60 °C
EAN code	4260405368723

Wheel Brush KS WB120



Max pressure	150 Bar
Gross weight	0.72 kg
EAN code	4260405368709

Suction Hose KS SPH 5M



Max pressure	up to 10
Hose length	5 m
EAN code	4260405368716



PRESSURE WASHERS



WATER PUMPS



Engine power



6,5-9,0 hp

Water lifting height



20 m-50 m

Reinforced steel frame



ø 28 mm

Starting system



manual

Könner & Söhnen® water pumps are dependable, high-performance machines designed for efficient liquid transfer. The range includes models for **domestic, agricultural, and professional applications**, covering every pumping need with proven reliability. Pumps, powered by **gasoline engines**, provide high mobility and efficiency, their **solid, stable design** ensures fast pumping of large water volumes — ideal for **draining flooded areas, basements, or reservoirs**, and for **supplying water to farms, irrigation systems, and even firefighting operations**. Range includes models for **clean, dirty, or aggressive liquids** (such as seawater or chemicals). Each pump features a **reinforced frame, durable engine, and enhanced power output** for reliable, long-term operation. Perfect for **households, farms, and garden use**, K&S pumps are **fully autonomous** and effective even in remote locations without power access.



RELIABLE BRAND ENGINES

Water pumps are powered by durable, fuel-efficient K&S branded engines, each has its unique serial number, meets **European quality requirements**, including the **EURO 5 standard**. Easy starting and low vibration levels ensure comfort, reliability, and long-term performance.

WE FEATURE MODELS FOR:

- ✓ Clean water
- ✓ Heavily contaminated water
- ✓ Chemical liquids (seawater, chemical substances)

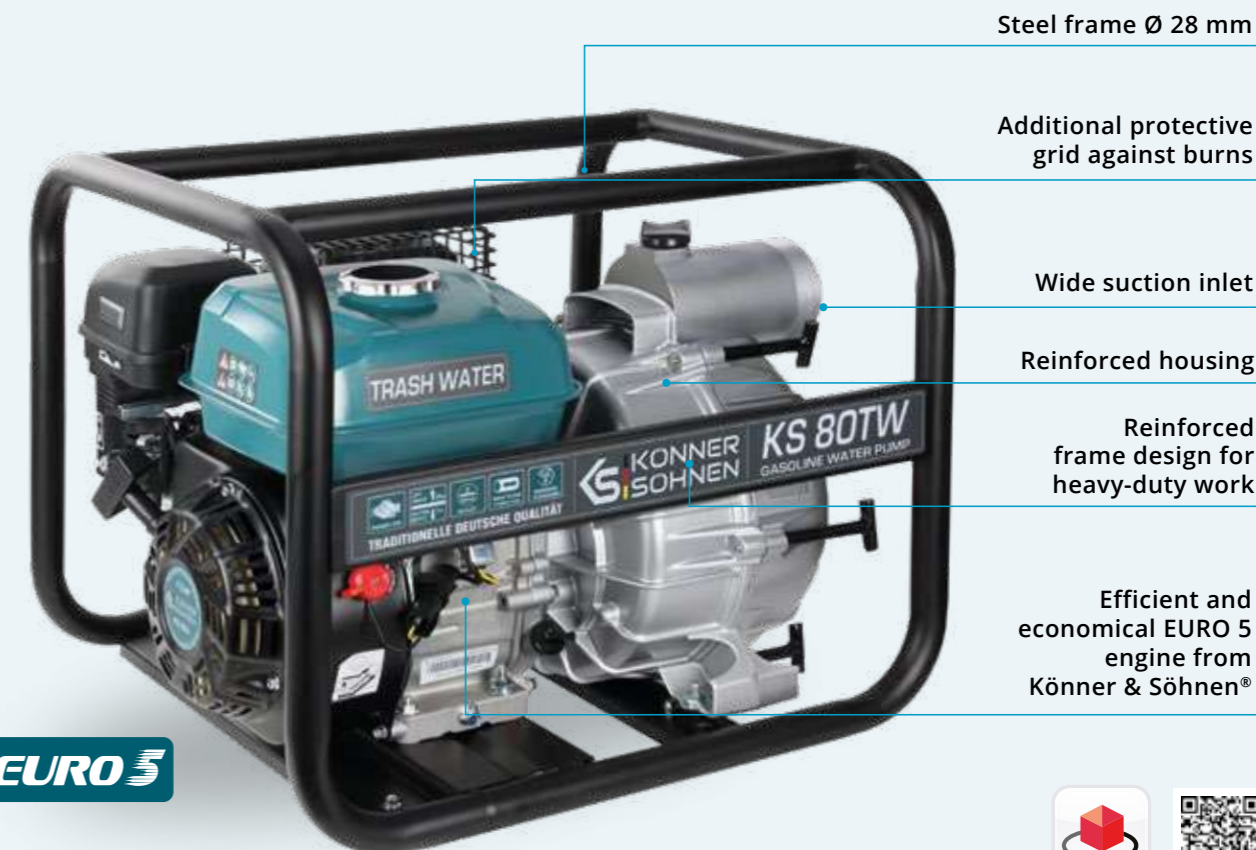

Steel frame Ø 28 mm

Additional protective grid against burns

Wide suction inlet

Reinforced housing

Reinforced frame design for heavy-duty work

Efficient and economical EURO 5 engine from Könner & Söhnen®



VIEW 3D MODEL



EQUIPMENT

The Könner & Söhnen® water pump housing is made of **durable aluminum**, resistant to **corrosion, temperature changes, and deformation**. A **large steel fuel tank** increases operating time and reduces the need for refueling.



VIBRATION DAMPERS

All models feature **rubber shock absorbers** that minimize vibration and protect both the surface and pump frame from damage during operation.



WATER PUMPS FOR CLEAN WATER

Könnner & Söhnen® engine-driven pumps for clean water (KS 50 and KS 80) are suitable for both domestic and industrial use. They are ideal for irrigation, water supply, pumping drinking water, draining pools or flooded areas, and for emergency response during accidents or floods. These models can also handle slightly contaminated water containing soft particles (algae, grass, leaves) up to 5 mm in size and with a concentration below 5%.



WATER PUMPS FOR HEAVILY CONTAMINATED WATER

The Könnner & Söhnen® KS 80MW water pump is built for heavily contaminated liquids and tough operating conditions. Its reinforced construction allows pumping large volumes of water containing solid particles up to 25 mm in diameter. Perfect for draining ponds and sewage systems, cleaning rivers and lakes, or pumping wastewater during well drilling, this pump delivers reliable performance and long service life even under the most demanding conditions.

KS 50



Pump type	for clean water
Max. capacity	500 l/min
Max. delivery head	28 m
Max. suction height	7 m
EAN code	4260405361342



KS 80 MW



Pump type	for heavily contaminated water
Max. capacity	1000 l/min
Max. delivery head	20 m
Max. suction height	7 m
EAN code	4260405364640



KS 80



Pump type	for clean water
Max. capacity	1000 l/min
Max. delivery head	28 m
Max. suction height	7 m
EAN code	4260405361359



WATER PUMPS FOR DIRTY WATER

The Könnner & Söhnen® KS 80TW dirty water pump is built for liquids containing up to 25% solid contaminants with particle sizes up to 20 x 25 mm. Its high performance makes it ideal for municipal services, agriculture, and construction sites, ensuring dependable operation in demanding conditions.

KS 80 TW



Pump type	for dirty water
Max. capacity	1100 l/min
Max. delivery head	26 m
Max. suction height	7 m
EAN code	4260405361373





ENGINE-DRIVEN PUMP FOR AGGRESSIVE LIQUIDS (SEA WATER, CHEMICAL SUBSTANCES)

This type of pumps is designed for pumping seawater, weak acids, and liquids with high ignition temperatures. It is suitable for use in agriculture (fertilizer application), as well as in the chemical and construction industries for transferring toxic or chemical solutions.

! Not intended for highly active, flammable, or solvent-based liquids, including gasoline.

KS 80 CW



Pump type	for aggressive liquids (seawater, chemical substances)
Max. capacity	1000 l/min
Max. delivery head	26 m
Max. suction height	7 m
EAN code	4260405364633



KS 80MW



KS 80TW



KS 80CW

Pump type	for heavily contaminated water	for dirty water	for chemical liquids (seawater, chemicals)
Inlet/outlet pipe diameter, mm	80/80	80/80	80/80
Max. capacity, l/min	1000	1000	1000
Nominal speed, rpm	3600	3600	3600
Max. delivery head, m	20	26	26
Max. suction height, m	7	7	7
Engine type	4-stroke gasoline	4-stroke gasoline	4-stroke gasoline
Engine model	KS 280	KS 250	KS 250
Engine power, hp	9,0	7,0	7,0
Engine displacement, cm ³	269	212	212
Starting system	manual	manual	manual
Fuel tank capacity, l	6,0	3,6	3,6
Noise level Lpa (7m)/Lwa, dB	79/104	79/104	79/104
Net dimensions (LxWxH), mm	720x535x600	530x460x435	590x420x450
Gross dimensions (LxWxH), mm	725x540x600	540x470x450	605x435x480
Net weight, kg	60	35	28
Gross weight, kg	63	37	30

QR Code



EAN code 4260405364640



EAN code 4260405361373



EAN code 4260405364633

ACCESSORIES FOR THIS PRODUCT (sold separately)
page: 100, 101



Köner & Söhnen® engines are reliable, efficient, and fuel-saving, fully compliant with European and global quality standards, including the latest EURO 5 emission requirements.

HIGH-PRESSURE WATER PUMPS

Köner & Söhnen® high-pressure engine-driven water pumps deliver a lifting height of up to 50 meters, making them ideal for firefighting, irrigation, and pumping clean water over long distances or to elevated areas. The KS 50HP fire pump features one 50 mm inlet and three outlets — one 50 mm and two 40 mm — enabling simultaneous water supply in 3 directions. This configuration ensures faster delivery and higher overall efficiency for demanding applications.

KS 50 HP



Pump type	high-pressure
Max. capacity	500 l/min
Max. delivery head	50 m
Max. suction height	7 m
EAN code	4260405361366



KS 50



KS 80



KS 50HP

Pump type	for clean water	for clean water	high-pressure
Inlet/outlet pipe diameter, mm	50/50	80/80	50/40, 50, 40
Max. capacity, l/min	500	1000	500
Nominal speed, rpm	3600	3600	3600
Max. delivery head, m	28	28	50
Max. suction height, m	7	7	7
Engine type	4-stroke gasoline	4-stroke gasoline	4-stroke gasoline
Engine model	KS 250	KS 250	KS 250
Engine power, hp	7	7	7,0
Engine displacement, cm ³	212	212	212
Starting system	manual	manual	manual
Fuel tank capacity, l	3,6	3,6	3,6
Noise level Lpa (7m)/Lwa, dB	79/104	79/104	79/104
Net dimensions (LxWxH), mm	490x400x410	490x400x410	485x434x432
Gross dimensions (LxWxH), mm	510x440x440	510x440x440	495x445x445
Net weight, kg	24	26	29
Gross weight, kg	26	28	31

QR Code



EAN code 4260405361342



EAN code 4260405361359



EAN code 4260405361366

ACCESSORIES FOR THIS PRODUCT (sold separately)
page: 100, 101





K&S ACCESSORIES

All presented accessories are **practical and essential** for operating **Könner & Söhnen®** equipment. We also offer **branded clothing and merchandise** that can be used for **sales, promotions, or customer loyalty programs**.

FUEL CANISTER



KS CAN 5

KS CAN 10

Special antistatic plastic

Capacity	5 l	10 l
Dimensions	260x128x255 mm	330x165x300 mm
EAN code	4260405362127	4260405363025



ENGINE OIL

Könner & Söhnen® semi-synthetic engine oil, produced in the **EU**, is suitable for both **gasoline and diesel engines**. The **SAE 10W-30 viscosity grade** ensures **fuel efficiency, reliable year-round performance**, and **long engine life**. It provides **excellent protection against wear**, features **anti-detergent and anti-corrosion additives**, and helps reduce fuel consumption.

ULTRA PERFORMANCE



KS 10W-30



Capacity	1 l
Quality class	API SL/CF
Viscosity	SAE 10W-30
EAN code	4260405362165

GEAR OIL

Könner & Söhnen® high-quality mineral gear oil (API GL-5 class) is suitable for a **wide range of mechanical transmissions** — including **transfer cases, hypoid gears, reducers, cardan drives, and vehicle axles**. Ideal for **cars, trucks, buses, and agricultural or construction machinery**, it provides **reliable protection and smooth operation year-round**.

ULTRA PERFORMANCE



KS GEAR OIL 80W-90



Capacity	1 l
Quality class	API GL-5
Viscosity	SAE 80W-90
EAN code	4260405364060

GASOLINE STABILIZER

KS G-STAB 60



Gasoline stabilizer **Könner & Söhnen®** ULTRA Performance series

Capacity	250 ml
Dosage	250 ml additive for 40–60 liters of gasoline
EAN code	4260405365388



- ✓ Preserves the original quality of fuel during storage
- ✓ Reliably preserves the fuel system during forced engine downtime
- ✓ Protects the electric fuel pump against corrosion and wear, even if moisture enters the system
- ✓ Ensures easy engine start after storage



Safety Glasses
KS GL-1



Polycarbonate glasses	1 pc
EAN code	4260405364770



Reliable hand protection against mechanical damage

Gloves
KS GLOVES L



100% natural leather + textile	
EAN code	4260405362547



Cap
CAP KS

Color	gray
-------	------



T-SHIRT KS

Men's sizes (M, L, XL)	Women's size (S)
------------------------	------------------



POLO KS

Men's sizes (M, L, XL)



RAGLAN KS

Men's sizes (M, L, XL)



BENEFITS FOR DEALERS

With more than **15 years of market experience**, **Könner & Söhnen®** offers partners a complete, ready-to-use business model — reliable products, strong marketing, and full after-sales support.

We understand the needs of every sales channel and create all the conditions for your success. The **Dimax Group** ensures customer service, warranty, and technical support across all markets where K&S equipment is sold.

WHY PARTNER WITH K&S

- ✓ High-quality products tested by time and demanding European customers
- ✓ Attractive cooperation terms and transparent partnership conditions
- ✓ Comprehensive marketing support: catalogues, visuals, videos, and showroom materials
- ✓ Pre-sales inspection and quality control of each batch in our European center
- ✓ Full after-sales service and training for sellers
- ✓ Original spare parts and official warranty

COMPLETE TURNKEY SOLUTION

By joining **Könner & Söhnen®**, you gain more than a product line — you gain a **ready-to-go business system** supported by a global brand, trusted by professionals and households across Europe.

We are invested in your success — let's grow together.

MARKETING & SERVICE SUPPORT

Our marketing team provides dealers with all essential tools — product photos, videos, POS materials, and online content — to help promote and sell effectively.

We also offer seller training and clear product documentation to simplify every step of the process.

EXTENDED WARRANTY — A STRONG SALES ADVANTAGE

Give your customers more confidence at no extra cost.

Some of Könner & Söhnen® products can be registered for an extended warranty — **up to 5 years for brushless motors** and **2 years for lithium-ion batteries, completely free of charge.**

This simple registration process (via QR code or warranty.konner-sohnen.com) takes less than two minutes and adds real value to every sale.

It means higher trust, easier conversions, and stronger brand loyalty - we are happy that customers appreciate long-term support directly from the manufacturer.

INTERNATIONAL CUSTOMER AND PARTNER SUPPORT

- ✓ Professional consultations on all technical matters
- ✓ Full after-sales customer service
- ✓ Training for sellers on Könner & Söhnen® equipment

PACKAGE OF VIDEO MATERIALS ON EQUIPMENT USE

- ✓ Getting started
- ✓ Commissioning
- ✓ Operation of individual functions
- ✓ Other

WARRANTY AND SERVICE

- ✓ High-quality service using original spare parts
- ✓ Provision of international warranty



WE ARE INTERESTED IN YOUR SUCCESS! WE INVITE YOU TO COOPERATE!



HIGH QUALITY



WIDE CUSTOMER SEGMENT



STAFF TRAINING



AFTER-SALES SERVICE

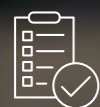

ATTRACTIVE COOPERATION CONDITIONS



PRE-SALES ACTIVITIES



COMPREHENSIVE MARKETING SUPPORT



HIGH-QUALITY TECHNICAL SERVICE



KONNER-SOHNEN.COM

ENERGY



GARDEN



AUTO



TRADITIONELLE DEUTSCHE QUALITÄT